

FEATURES

- Dual-Supply Operation . . . $\pm 5\text{ V}$ to $\pm 18\text{ V}$
- Low Noise Voltage . . . $4.5\text{ nV}/\sqrt{\text{Hz}}$
- Low Input Offset Voltage . . . 0.15 mV
- Low Total Harmonic Distortion . . . 0.002%
- High Slew Rate . . . $7\text{ V}/\mu\text{s}$
- High-Gain Bandwidth Product . . . 16 MHz
- High Open-Loop AC Gain . . . 800 at 20 kHz
- Large Output-Voltage Swing . . . 14.1 V to -14.6 V
- Excellent Gain and Phase Margins

D (SOIC), DGK (MSOP), OR P (PDIP) PACKAGE
(TOP VIEW)

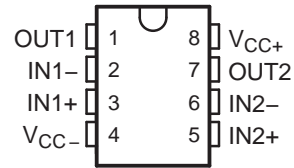

DESCRIPTION/ORDERING INFORMATION

The MC33078 is a bipolar dual operational amplifier with high-performance specifications for use in quality audio and data-signal applications. This device operates over a wide range of single- and dual-supply voltages and offers low noise, high-gain bandwidth, and high slew rate. Additional features include low total harmonic distortion, excellent phase and gain margins, large output voltage swing with no deadband crossover distortion, and symmetrical sink/source performance.

ORDERING INFORMATION

T_A	PACKAGE ⁽¹⁾		ORDERABLE PART NUMBER	TOP-SIDE MARKING ⁽²⁾
-40°C to 85°C	PDIP – P	Tube of 50	MC33078P	MC33078P
	SOIC – D	Tube of 75	MC33078D	M33078
		Reel of 2500	MC33078DR	
	VSSOP/MSOP – DGK	Reel of 2500	MC33078DGKR	MY_
		Reel of 250	MC33078DGKT	

(1) Package drawings, standard packing quantities, thermal data, symbolization, and PCB design guidelines are available at www.ti.com/sc/package.

(2) DGK: The actual top-side marking has one additional character that designates the assembly/test site.

SYMBOL (EACH AMPLIFIER)

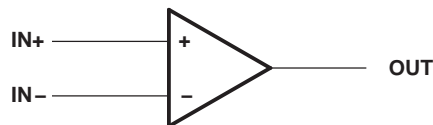

Please be aware that an important notice concerning availability, standard warranty, and use in critical applications of Texas Instruments semiconductor products and disclaimers thereto appears at the end of this data sheet.

Absolute Maximum Ratings⁽¹⁾

over operating free-air temperature range (unless otherwise noted)

		MIN	MAX	UNIT
V _{CC+}	Supply voltage ⁽²⁾		18	V
V _{CC-}	Supply voltage ⁽²⁾		-18	V
V _{CC+} - V _{CC-}	Supply voltage		36	V
	Input voltage, either input ⁽²⁾⁽³⁾		V _{CC+} or V _{CC-}	V
	Input current ⁽⁴⁾		±10	mA
	Duration of output short circuit ⁽⁵⁾		Unlimited	
θ _{JA}	Package thermal impedance, junction to free air ⁽⁶⁾⁽⁷⁾	D package	97	°C/W
		DGK package	172	
		P package	85	
T _J	Operating virtual junction temperature		150	°C
T _{stg}	Storage temperature range	-65	150	°C

- (1) Stresses beyond those listed under *Absolute Maximum Ratings* may cause permanent damage to the device. These are stress ratings only, and functional operation of the device at these or any other conditions beyond those indicated under *Recommended Operating Conditions* is not implied. Exposure to absolute-maximum-rated conditions for extended periods may affect device reliability.
- (2) All voltage values, except differential voltages, are with respect to the midpoint between V_{CC+} and V_{CC-}.
- (3) The magnitude of the input voltage must never exceed the magnitude of the supply voltage.
- (4) Excessive input current will flow if a differential input voltage in excess of approximately 0.6 V is applied between the inputs, unless some limiting resistance is used.
- (5) The output may be shorted to ground or either power supply. Temperature and/or supply voltages must be limited to ensure the maximum dissipation rating is not exceeded.
- (6) Maximum power dissipation is a function of T_{J(max)}, θ_{JA}, and T_A. The maximum allowable power dissipation at any allowable ambient temperature is P_D = (T_{J(max)} - T_A)/θ_{JA}. Operating at the absolute maximum T_J of 150°C can affect reliability.
- (7) The package thermal impedance is calculated in accordance with JESD 51-7.

Recommended Operating Conditions

		MIN	MAX	UNIT
V _{CC-}	Supply voltage	-5	-18	V
V _{CC+}		5	18	
T _A	Operating free-air temperature range	-40	85	°C

Electrical Characteristics

$V_{CC-} = -15\text{ V}$, $V_{CC+} = 15\text{ V}$, $T_A = 25^\circ\text{C}$ (unless otherwise noted)

PARAMETER		TEST CONDITIONS		MIN	TYP	MAX	UNIT
V_{IO}	Input offset voltage	$V_O = 0$, $R_S = 10\ \Omega$, $V_{CM} = 0$	$T_A = 25^\circ\text{C}$	0.15	2	3	mV
			$T_A = -40^\circ\text{C}$ to 85°C				
αV_{IO}	Input offset voltage temperature coefficient	$V_O = 0$, $R_S = 10\ \Omega$, $V_{CM} = 0$	$T_A = -40^\circ\text{C}$ to 85°C		2		$\mu\text{V}/^\circ\text{C}$
I_{IB}	Input bias current	$V_O = 0$, $V_{CM} = 0$	$T_A = 25^\circ\text{C}$		300	750	nA
			$T_A = -40^\circ\text{C}$ to 85°C			800	
I_{IO}	Input offset current	$V_O = 0$, $V_{CM} = 0$	$T_A = 25^\circ\text{C}$		25	150	nA
			$T_A = -40^\circ\text{C}$ to 85°C			175	
V_{ICR}	Common-mode input voltage range	$\Delta V_{IO} = 5\text{ mV}$, $V_O = 0$		± 13	± 14		V
A_{VD}	Large-signal differential voltage amplification	$R_L \geq 2\text{ k}\Omega$, $V_O = \pm 10\text{ V}$	$T_A = 25^\circ\text{C}$	90	110		dB
			$T_A = -40^\circ\text{C}$ to 85°C	85			
V_{OM}	Maximum output voltage swing	$V_{ID} = \pm 1\text{ V}$	$R_L = 600\ \Omega$	V_{OM+}	10.7		V
				V_{OM-}	-11.9		
			$R_L = 2\text{ k}\Omega$	V_{OM+}	13.2	13.8	
				V_{OM-}	-13.2	-13.7	
			$R_L = 10\text{ k}\Omega$	V_{OM+}	13.5	14.1	
				V_{OM-}	-14	-14.6	
CMMR	Common-mode rejection ratio	$V_{IN} = \pm 13\text{ V}$		80	100		dB
$k_{SVR}^{(1)}$	Supply-voltage rejection ratio	$V_{CC+} = 5\text{ V}$ to 15 V , $V_{CC-} = -5\text{ V}$ to -15 V		80	105		dB
I_{OS}	Output short-circuit current	$ V_{ID} = 1\text{ V}$, Output to GND	Source current	15	29		mA
			Sink current	-20	-37		
I_{CC}	Supply current (per channel)	$V_O = 0$	$T_A = 25^\circ\text{C}$		2.05	2.5	mA
			$T_A = -40^\circ\text{C}$ to 85°C			2.75	

(1) Measured with $V_{CC\pm}$ differentially varied at the same time

Operating Characteristics

$V_{CC-} = -15\text{ V}$, $V_{CC+} = 15\text{ V}$, $T_A = 25^\circ\text{C}$ (unless otherwise noted)

PARAMETER		TEST CONDITIONS		MIN	TYP	MAX	UNIT
SR	Slew rate at unity gain	$A_{VD} = 1$, $V_{IN} = -10\text{ V}$ to 10 V , $R_L = 2\text{ k}\Omega$, $C_L = 100\text{ pF}$		5	7		V/ μs
GBW	Gain bandwidth product	$f = 100\text{ kHz}$		10	16		MHz
B_1	Unity gain frequency	Open loop			9		MHz
G_m	Gain margin	$R_L = 2\text{ k}\Omega$	$C_L = 0\text{ pF}$		-11		dB
			$C_L = 100\text{ pF}$		-6		
Φ_m	Phase margin	$R_L = 2\text{ k}\Omega$	$C_L = 0\text{ pF}$		55		deg
			$C_L = 100\text{ pF}$		40		
	Amp-to-amp isolation	$f = 20\text{ Hz}$ to 20 kHz			-120		dB
	Power bandwidth	$V_O = 27\text{ V}_{(PP)}$, $R_L = 2\text{ k}\Omega$, $\text{THD} \leq 1\%$			120		kHz
THD	Total harmonic distortion	$V_O = 3\text{ V}_{rms}$, $A_{VD} = 1$, $R_L = 2\text{ k}\Omega$, $f = 20\text{ Hz}$ to 20 kHz			0.002		%
Z_o	Open-loop output impedance	$V_O = 0$, $f = 9\text{ MHz}$			37		Ω
r_{id}	Differential input resistance	$V_{CM} = 0$			175		k Ω
C_{id}	Differential input capacitance	$V_{CM} = 0$			12		pF
V_n	Equivalent input noise voltage	$f = 1\text{ kHz}$, $R_S = 100\ \Omega$			4.5		nV/ $\sqrt{\text{Hz}}$
I_n	Equivalent input noise current	$f = 1\text{ kHz}$			0.5		pA/ $\sqrt{\text{Hz}}$

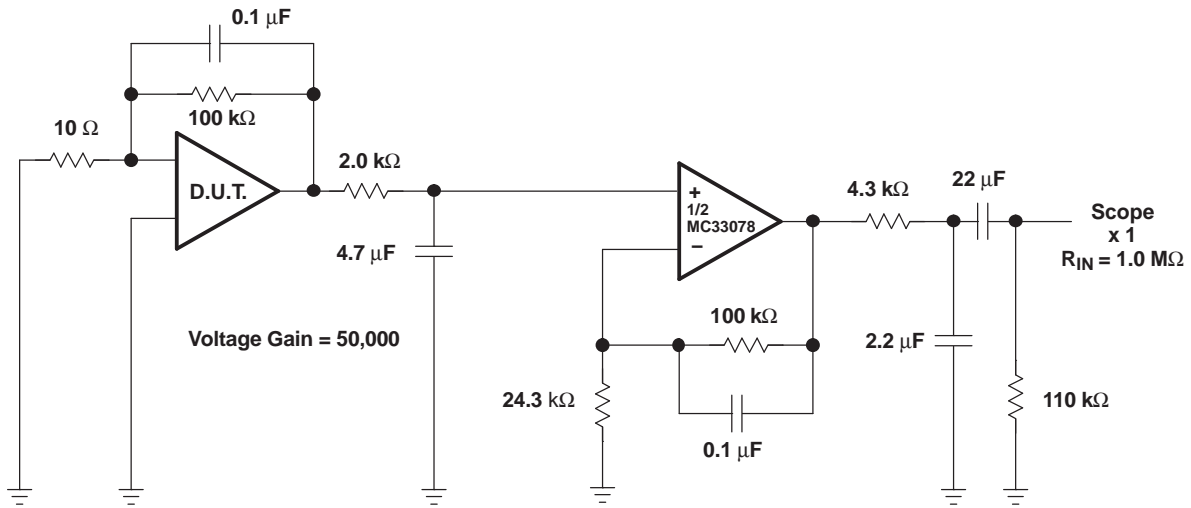

NOTE: All capacitors are non-polarized.

Figure 1. Voltage Noise Test Circuit (0.1 Hz to 10 Hz)

TYPICAL CHARACTERISTICS

INPUT BIAS CURRENT
 VS
COMMON-MODE VOLTAGE



INPUT BIAS CURRENT
 VS
SUPPLY VOLTAGE

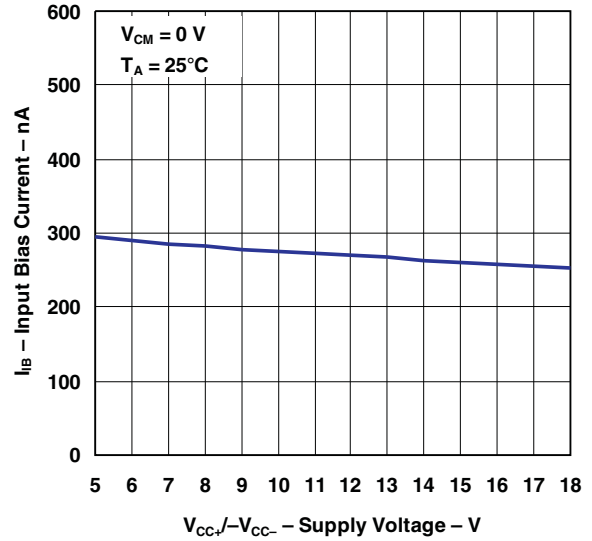

INPUT BIAS CURRENT
 VS
TEMPERATURE

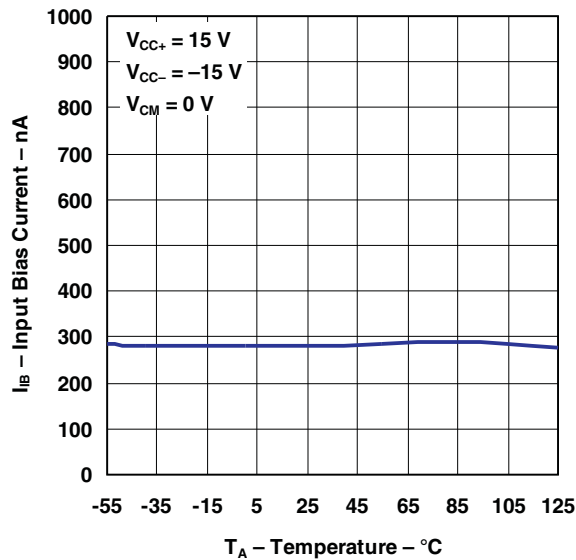

INPUT OFFSET VOLTAGE
 VS
TEMPERATURE

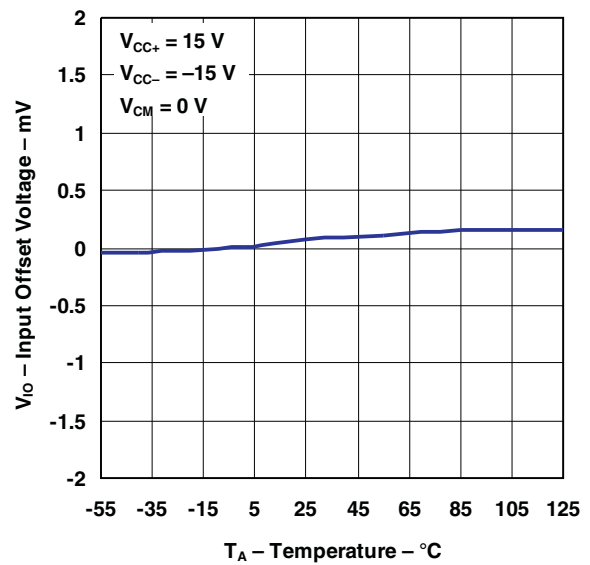

TYPICAL CHARACTERISTICS (continued)

INPUT COMMON-MODE VOLTAGE
 LOW PROXIMITY TO V_{CC-}
 VS
 TEMPERATURE

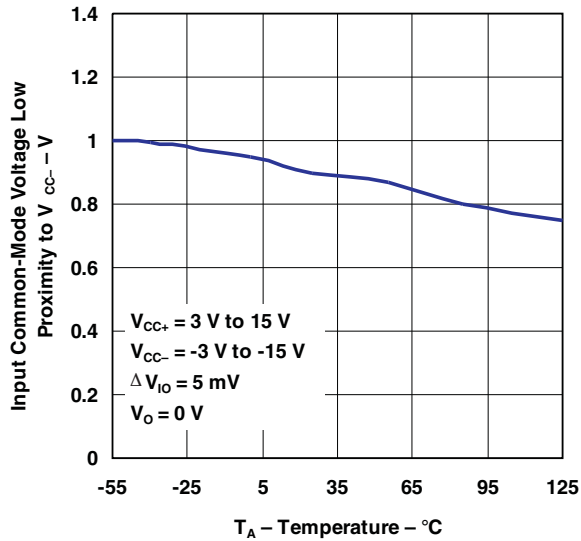

INPUT COMMON-MODE VOLTAGE
 HIGH PROXIMITY TO V_{CC+}
 VS
 TEMPERATURE

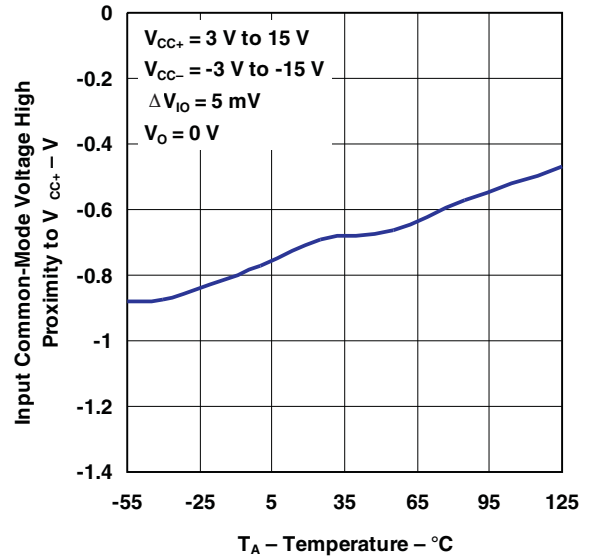

OUTPUT SATURATION VOLTAGE PROXIMITY TO V_{CC+}
 VS
 LOAD RESISTANCE

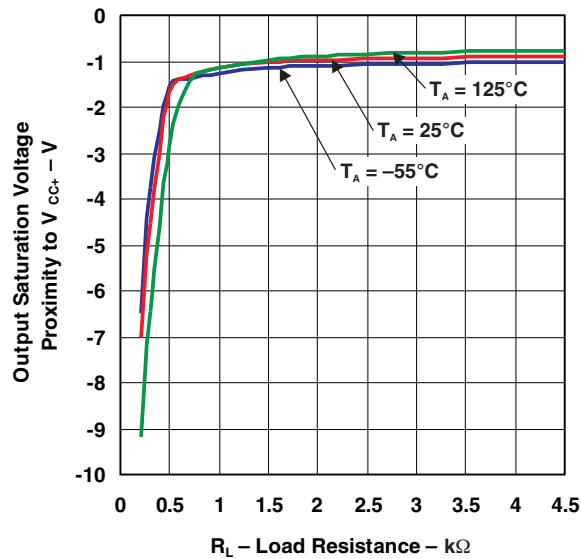

OUTPUT SATURATION VOLTAGE PROXIMITY TO V_{CC-}
 VS
 LOAD RESISTANCE

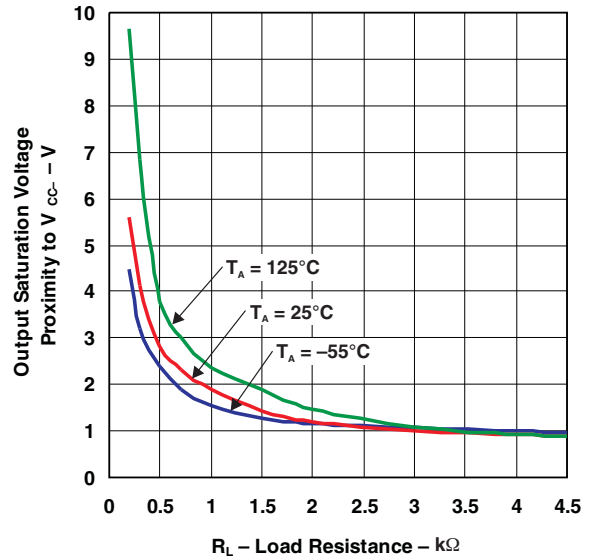

TYPICAL CHARACTERISTICS (continued)

**OUTPUT SHORT-CIRCUIT CURRENT
VS
TEMPERATURE**

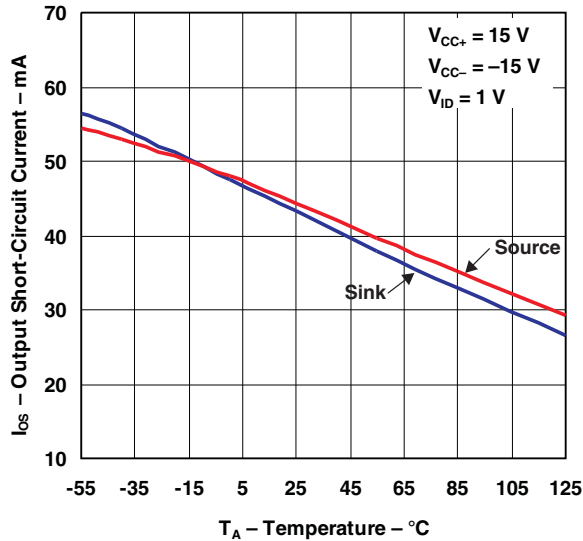

**SUPPLY CURRENT
VS
TEMPERATURE**

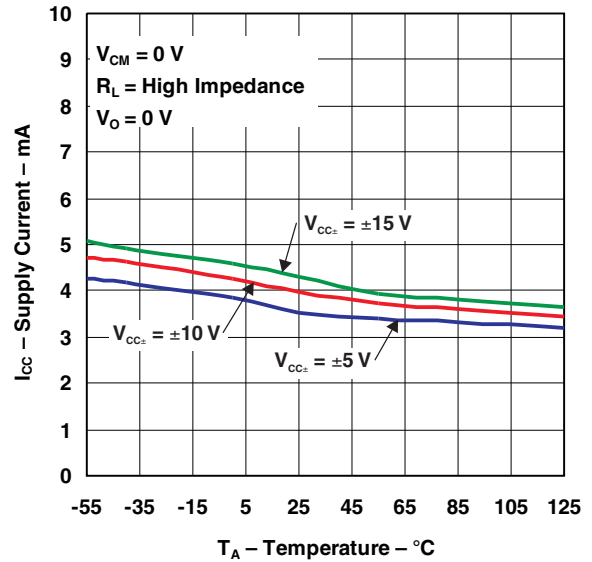

**CMRR
VS
FREQUENCY**

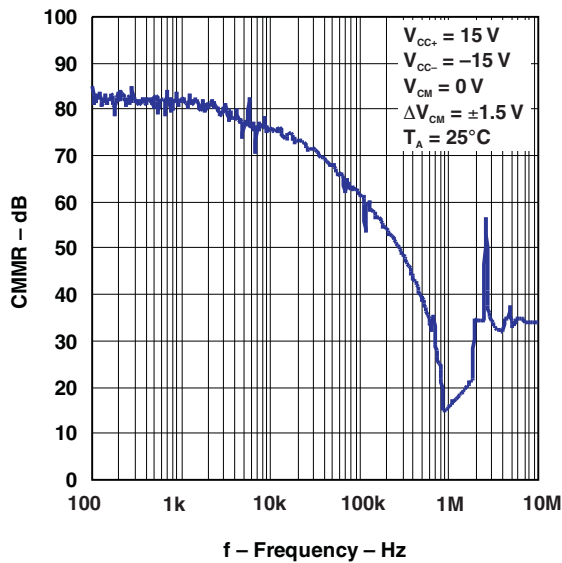

**PSSR
VS
FREQUENCY**

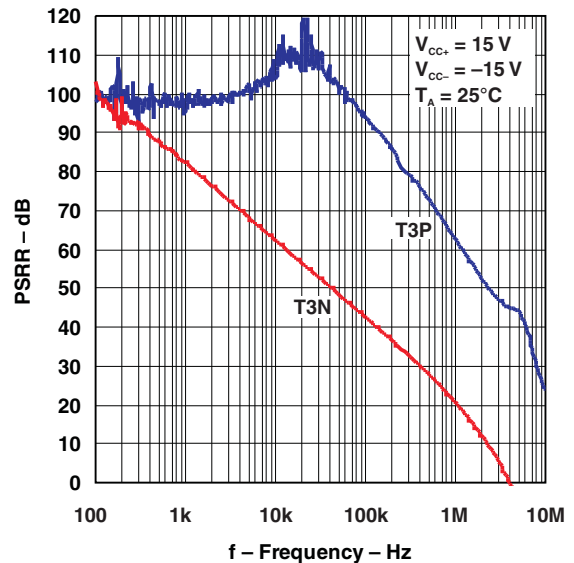

TYPICAL CHARACTERISTICS (continued)

GAIN BANDWIDTH PRODUCT
 VS
 SUPPLY VOLTAGE

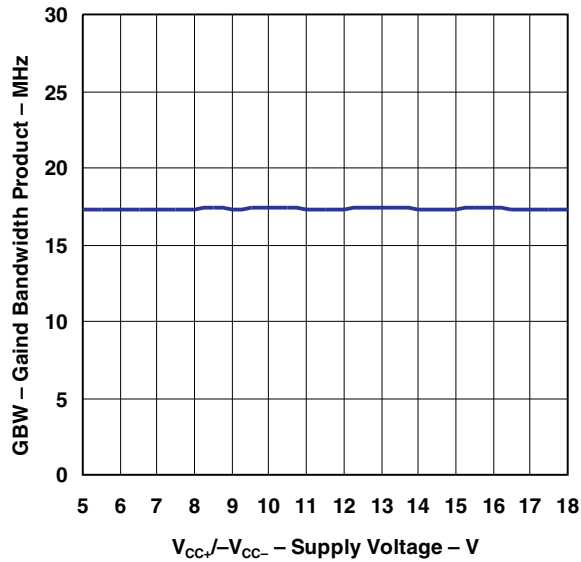

GAIN BANDWIDTH PRODUCT
 VS
 TEMPERATURE

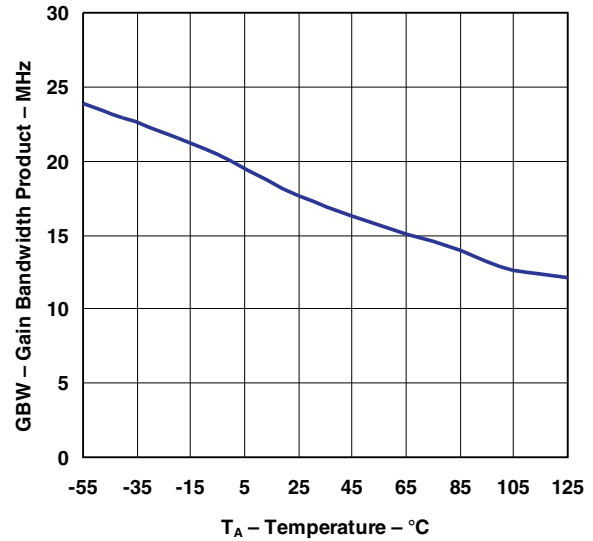

OUTPUT VOLTAGE
 VS
 SUPPLY VOLTAGE

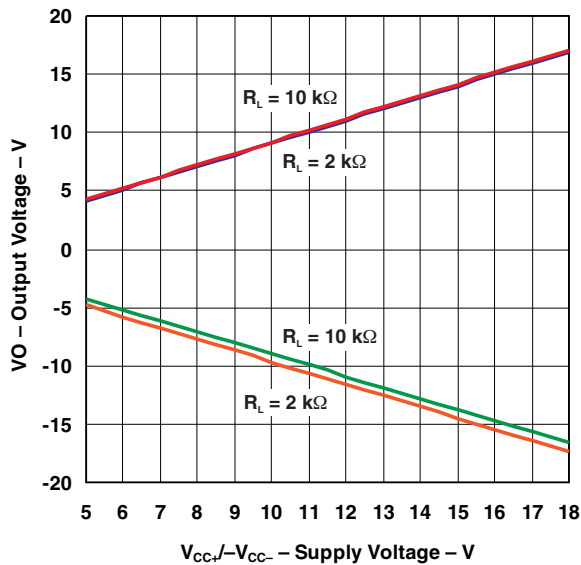

OUTPUT VOLTAGE
 VS
 FREQUENCY

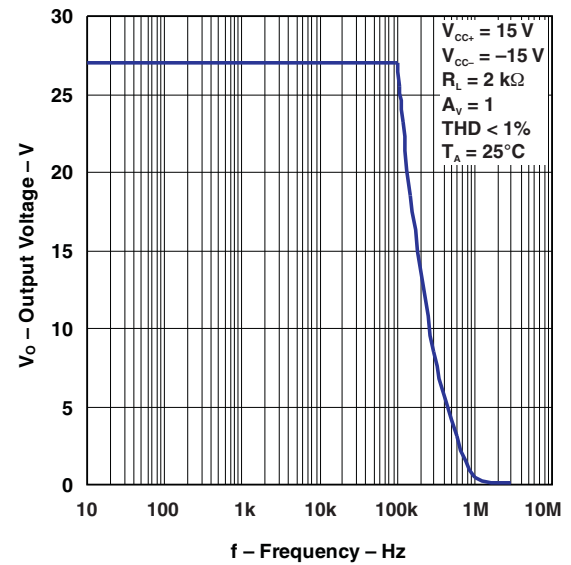

TYPICAL CHARACTERISTICS (continued)

**OPEN-LOOP GAIN
VS
SUPPLY VOLTAGE**

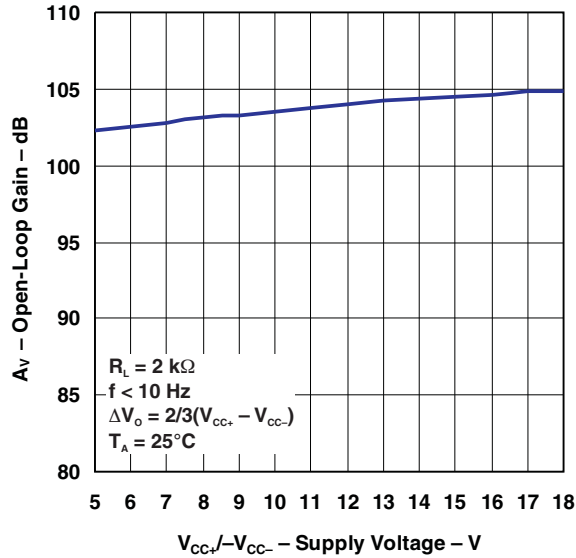

**OPEN-LOOP GAIN
VS
TEMPERATURE**

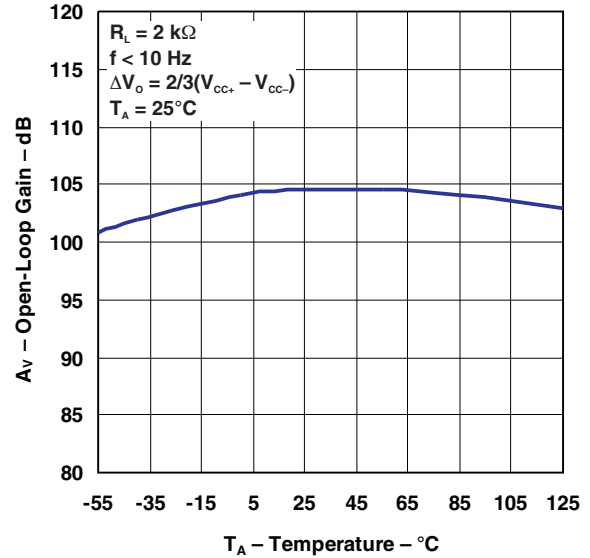

**OUTPUT IMPEDANCE
VS
FREQUENCY**

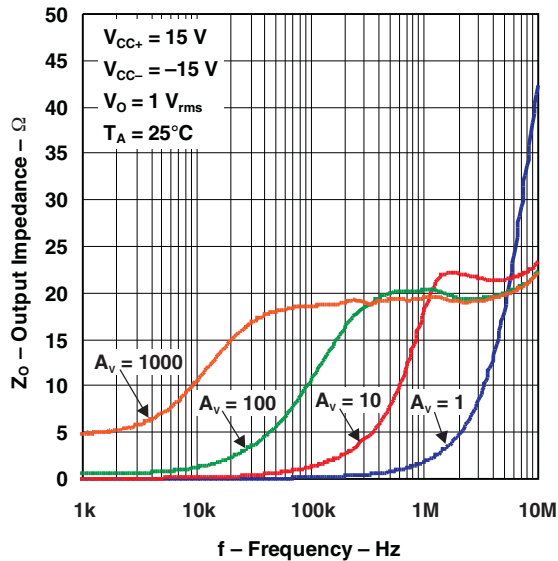

**CROSSTALK REJECTION
VS
FREQUENCY**

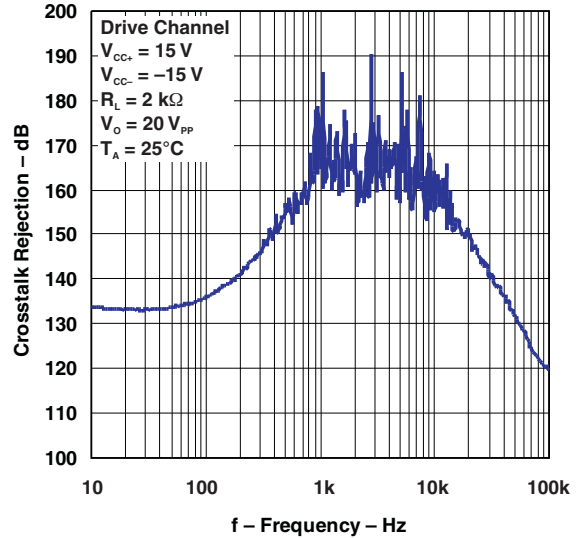

TYPICAL CHARACTERISTICS (continued)

TOTAL HARMONIC DISTORTION
 VS
 FREQUENCY

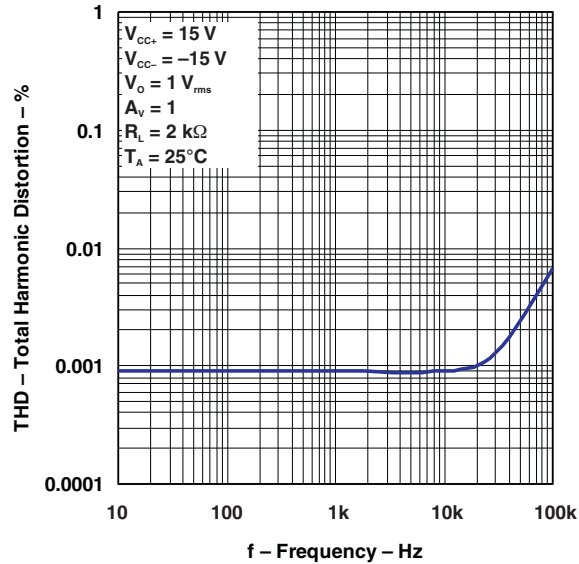

TOTAL HARMONIC DISTORTION
 VS
 OUTPUT VOLTAGE

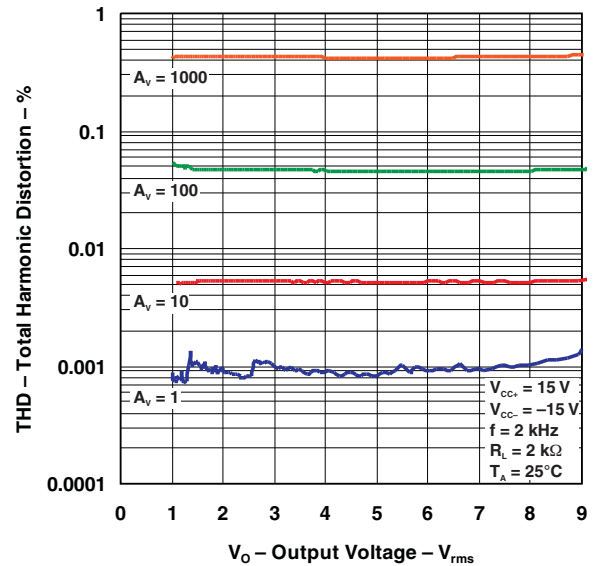

SLEW RATE
 VS
 SUPPLY VOLTAGE

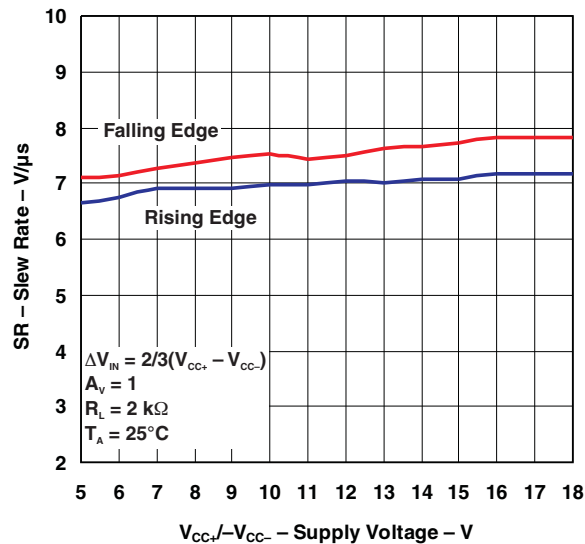

SLEW RATE
 VS
 TEMPERATURE

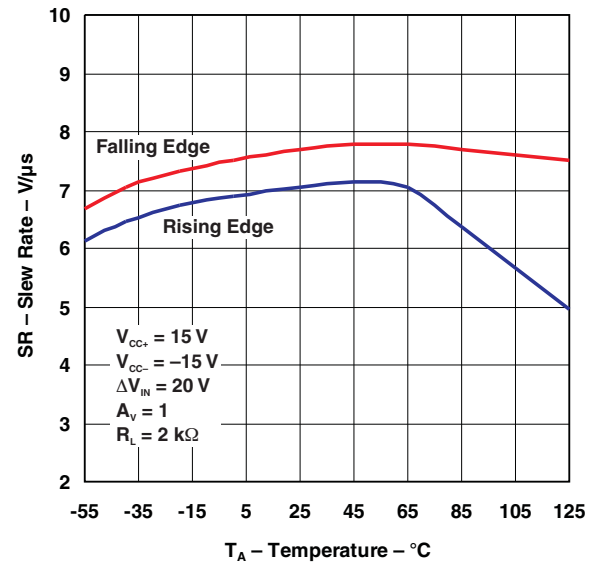

TYPICAL CHARACTERISTICS (continued)

GAIN AND PHASE VS FREQUENCY

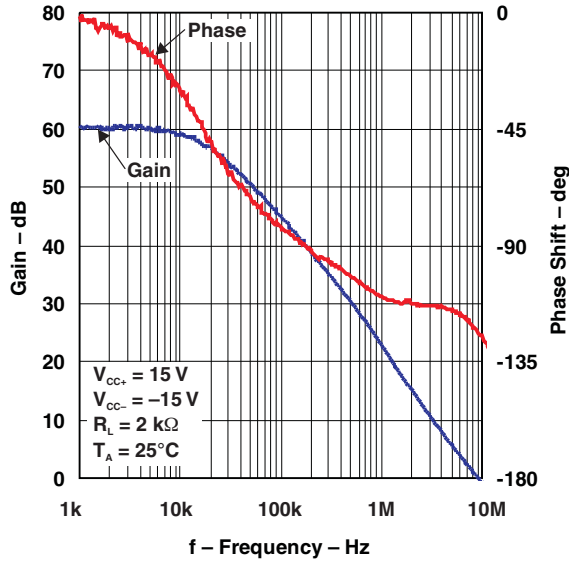

GAIN AND PHASE MARGIN VS OUTPUT LOAD CAPACITANCE

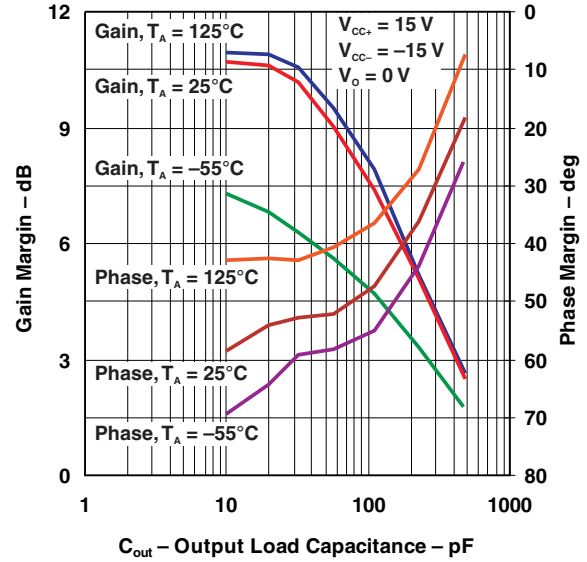

OVERSHOOT VS OUTPUT LOAD CAPACITANCE

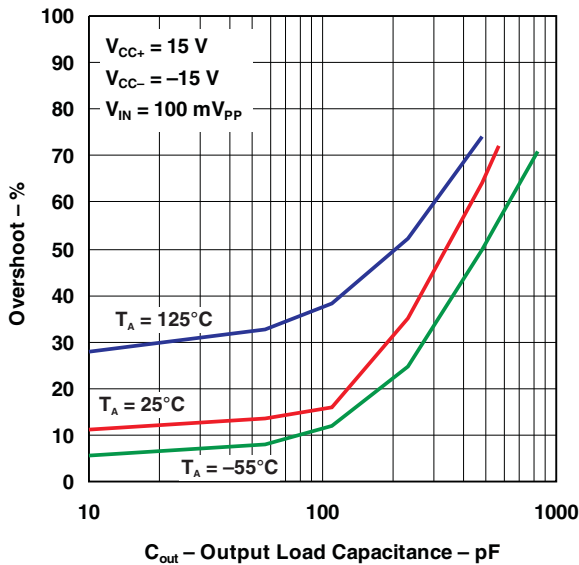

INPUT VOLTAGE AND CURRENT NOISE VS FREQUENCY

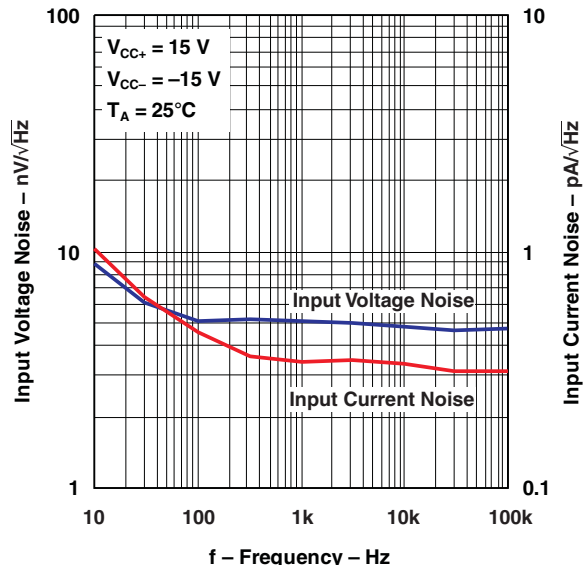

TYPICAL CHARACTERISTICS (continued)

INPUT REFERRED NOISE VOLTAGE
 VS
 SOURCE RESISTANCE

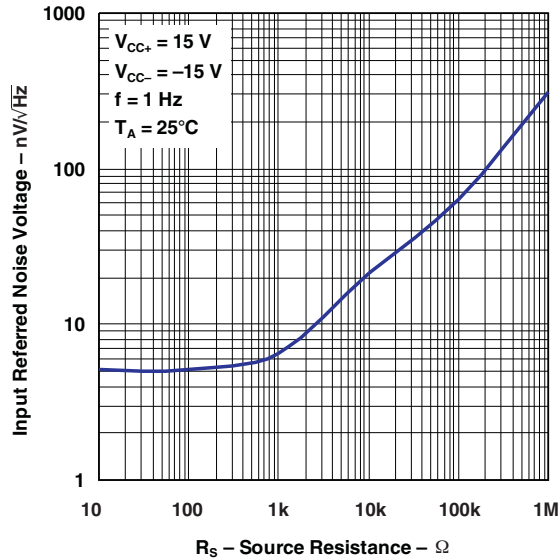

GAIN AND PHASE MARGIN
 VS
 DIFFERENTIAL SOURCE RESISTANCE

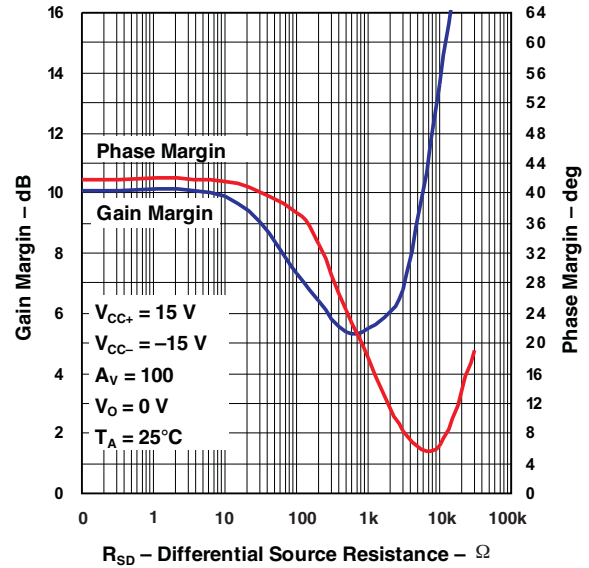

LARGE SIGNAL TRANSIENT RESPONSE
 ($A_V = 1$)

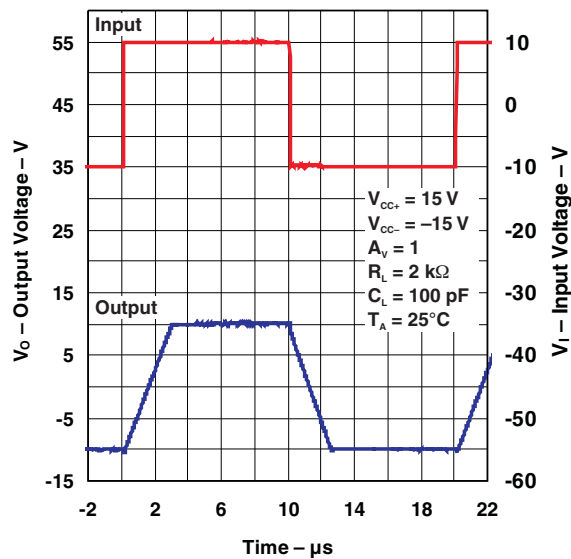

LARGE SIGNAL TRANSIENT RESPONSE
 ($A_V = -1$)

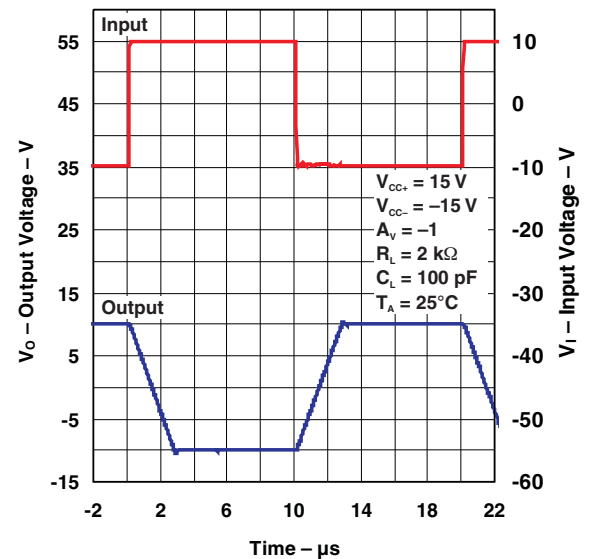

TYPICAL CHARACTERISTICS (continued)

SMALL SIGNAL TRANSIENT RESPONSE

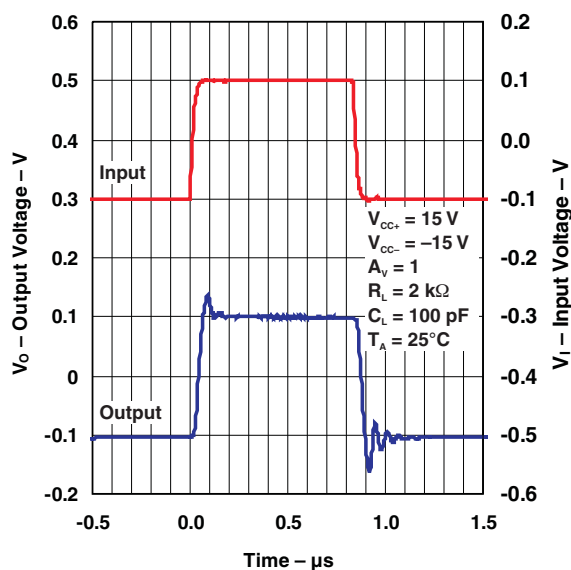

LOW_FREQUENCY NOISE

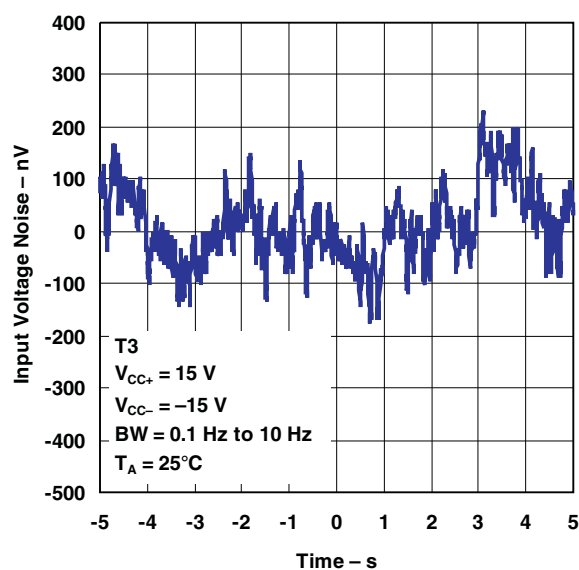

APPLICATION INFORMATION

Output Characteristics

All operating characteristics are specified with 100-pF load capacitance. The MC33078 can drive higher capacitance loads. However, as the load capacitance increases, the resulting response pole occurs at lower frequencies, causing ringing, peaking, or oscillation. The value of the load capacitance at which oscillation occurs varies from lot to lot. If an application appears to be sensitive to oscillation due to load capacitance, adding a small resistance in series with the load should alleviate the problem (see Figure 2).

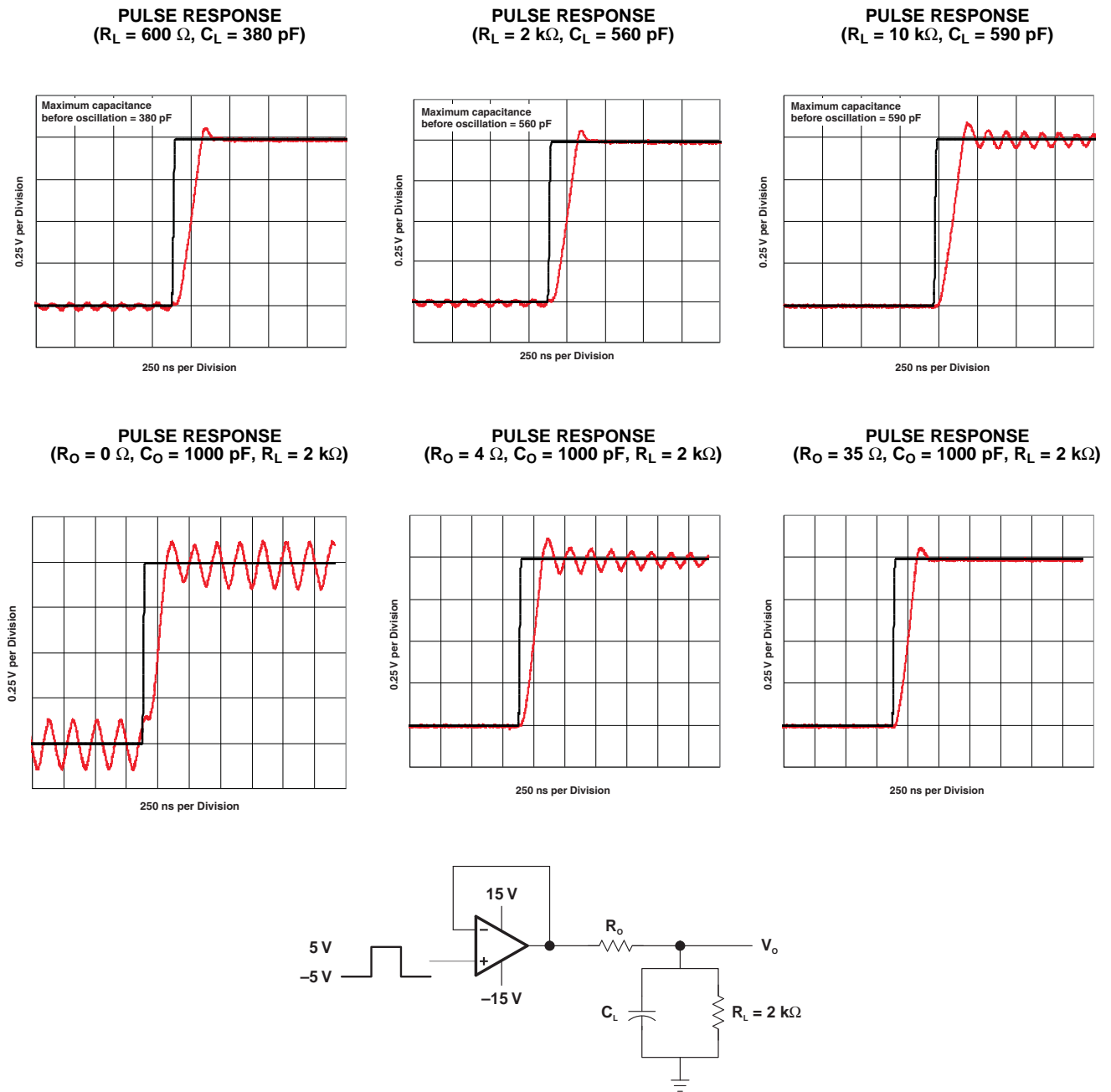

Figure 2. Output Characteristics

PACKAGING INFORMATION

Orderable Device	Status (1)	Package Type	Package Drawing	Pins	Package Qty	Eco Plan (2)	Lead/Ball Finish	MSL Peak Temp (3)	Op Temp (°C)	Top-Side Markings (4)	Samples
MC33078D	ACTIVE	SOIC	D	8	75	Green (RoHS & no Sb/Br)	CU NIPDAU	Level-1-260C-UNLIM	-40 to 85	M33078	Samples
MC33078DE4	ACTIVE	SOIC	D	8	75	Green (RoHS & no Sb/Br)	CU NIPDAU	Level-1-260C-UNLIM	-40 to 85	M33078	Samples
MC33078DG4	ACTIVE	SOIC	D	8	75	Green (RoHS & no Sb/Br)	CU NIPDAU	Level-1-260C-UNLIM	-40 to 85	M33078	Samples
MC33078DGKR	ACTIVE	VSSOP	DGK	8	2500	Green (RoHS & no Sb/Br)	CU NIPDAU	Level-1-260C-UNLIM	-40 to 85	MYU	Samples
MC33078DGKRG4	ACTIVE	VSSOP	DGK	8	2500	Green (RoHS & no Sb/Br)	CU NIPDAU	Level-1-260C-UNLIM	-40 to 85	MYU	Samples
MC33078DGKT	ACTIVE	VSSOP	DGK	8	250	Green (RoHS & no Sb/Br)	CU NIPDAU	Level-1-260C-UNLIM	-40 to 85	MYU	Samples
MC33078DGKTG4	ACTIVE	VSSOP	DGK	8	250	Green (RoHS & no Sb/Br)	CU NIPDAU	Level-1-260C-UNLIM	-40 to 85	MYU	Samples
MC33078DR	ACTIVE	SOIC	D	8	2500	Green (RoHS & no Sb/Br)	CU NIPDAU	Level-1-260C-UNLIM	-40 to 85	M33078	Samples
MC33078DRE4	ACTIVE	SOIC	D	8	2500	Green (RoHS & no Sb/Br)	CU NIPDAU	Level-1-260C-UNLIM	-40 to 85	M33078	Samples
MC33078DRG4	ACTIVE	SOIC	D	8	2500	Green (RoHS & no Sb/Br)	CU NIPDAU	Level-1-260C-UNLIM	-40 to 85	M33078	Samples
MC33078P	ACTIVE	PDIP	P	8	50	Pb-Free (RoHS)	CU NIPDAU	N / A for Pkg Type	-40 to 85	MC33078P	Samples
MC33078PE4	ACTIVE	PDIP	P	8	50	Pb-Free (RoHS)	CU NIPDAU	N / A for Pkg Type	-40 to 85	MC33078P	Samples

(1) The marketing status values are defined as follows:

ACTIVE: Product device recommended for new designs.

LIFEBUY: TI has announced that the device will be discontinued, and a lifetime-buy period is in effect.

NRND: Not recommended for new designs. Device is in production to support existing customers, but TI does not recommend using this part in a new design.

PREVIEW: Device has been announced but is not in production. Samples may or may not be available.

OBSOLETE: TI has discontinued the production of the device.

(2) Eco Plan - The planned eco-friendly classification: Pb-Free (RoHS), Pb-Free (RoHS Exempt), or Green (RoHS & no Sb/Br) - please check <http://www.ti.com/productcontent> for the latest availability information and additional product content details.

TBD: The Pb-Free/Green conversion plan has not been defined.

Pb-Free (RoHS): TI's terms "Lead-Free" or "Pb-Free" mean semiconductor products that are compatible with the current RoHS requirements for all 6 substances, including the requirement that lead not exceed 0.1% by weight in homogeneous materials. Where designed to be soldered at high temperatures, TI Pb-Free products are suitable for use in specified lead-free processes.

Pb-Free (RoHS Exempt): This component has a RoHS exemption for either 1) lead-based flip-chip solder bumps used between the die and package, or 2) lead-based die adhesive used between the die and leadframe. The component is otherwise considered Pb-Free (RoHS compatible) as defined above.

Green (RoHS & no Sb/Br): TI defines "Green" to mean Pb-Free (RoHS compatible), and free of Bromine (Br) and Antimony (Sb) based flame retardants (Br or Sb do not exceed 0.1% by weight in homogeneous material)

⁽³⁾ MSL, Peak Temp. -- The Moisture Sensitivity Level rating according to the JEDEC industry standard classifications, and peak solder temperature.

⁽⁴⁾ Multiple Top-Side Markings will be inside parentheses. Only one Top-Side Marking contained in parentheses and separated by a "~" will appear on a device. If a line is indented then it is a continuation of the previous line and the two combined represent the entire Top-Side Marking for that device.

Important Information and Disclaimer: The information provided on this page represents TI's knowledge and belief as of the date that it is provided. TI bases its knowledge and belief on information provided by third parties, and makes no representation or warranty as to the accuracy of such information. Efforts are underway to better integrate information from third parties. TI has taken and continues to take reasonable steps to provide representative and accurate information but may not have conducted destructive testing or chemical analysis on incoming materials and chemicals. TI and TI suppliers consider certain information to be proprietary, and thus CAS numbers and other limited information may not be available for release.

In no event shall TI's liability arising out of such information exceed the total purchase price of the TI part(s) at issue in this document sold by TI to Customer on an annual basis.

OTHER QUALIFIED VERSIONS OF MC33078 :

- Enhanced Product: [MC33078-EP](#)

NOTE: Qualified Version Definitions:

- Enhanced Product - Supports Defense, Aerospace and Medical Applications

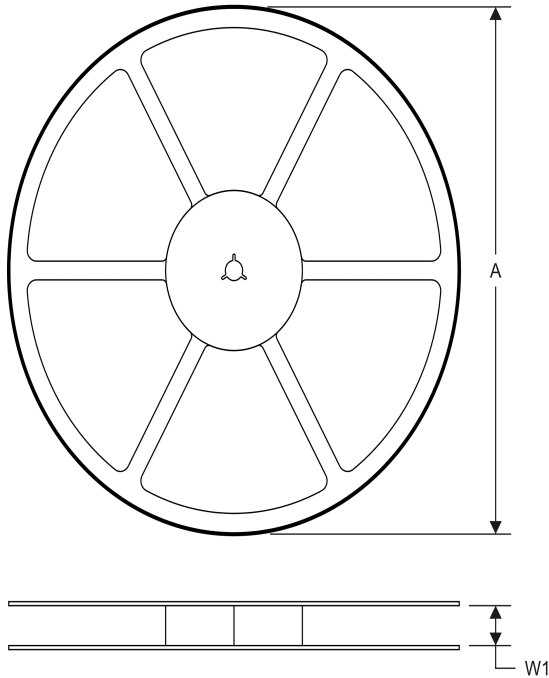
TAPE AND REEL INFORMATION
REEL DIMENSIONS

TAPE DIMENSIONS

A0	Dimension designed to accommodate the component width
B0	Dimension designed to accommodate the component length
K0	Dimension designed to accommodate the component thickness
W	Overall width of the carrier tape
P1	Pitch between successive cavity centers

TAPE AND REEL INFORMATION

*All dimensions are nominal

Device	Package Type	Package Drawing	Pins	SPQ	Reel Diameter (mm)	Reel Width W1 (mm)	A0 (mm)	B0 (mm)	K0 (mm)	P1 (mm)	W (mm)	Pin1 Quadrant
MC33078DGKR	VSSOP	DGK	8	2500	330.0	12.4	5.3	3.3	1.3	8.0	12.0	Q1
MC33078DGKT	VSSOP	DGK	8	250	180.0	12.4	5.3	3.3	1.3	8.0	12.0	Q1
MC33078DR	SOIC	D	8	2500	330.0	12.4	6.4	5.2	2.1	8.0	12.0	Q1
MC33078DR	SOIC	D	8	2500	330.0	12.4	6.4	5.2	2.1	8.0	12.0	Q1

TAPE AND REEL BOX DIMENSIONS

*All dimensions are nominal

Device	Package Type	Package Drawing	Pins	SPQ	Length (mm)	Width (mm)	Height (mm)
MC33078DGKR	VSSOP	DGK	8	2500	346.0	346.0	35.0
MC33078DGKT	VSSOP	DGK	8	250	220.0	205.0	50.0
MC33078DR	SOIC	D	8	2500	367.0	367.0	35.0
MC33078DR	SOIC	D	8	2500	340.5	338.1	20.6

P (R-PDIP-T8)

PLASTIC DUAL-IN-LINE PACKAGE



- NOTES:
- A. All linear dimensions are in inches (millimeters).
 - B. This drawing is subject to change without notice.
 - C. Falls within JEDEC MS-001 variation BA.

DGK (S-PDSO-G8)

PLASTIC SMALL-OUTLINE PACKAGE



4073329/E 05/06

- NOTES:
- A. All linear dimensions are in millimeters.
 - B. This drawing is subject to change without notice.
 - C. Body length does not include mold flash, protrusions, or gate burrs. Mold flash, protrusions, or gate burrs shall not exceed 0.15 per end.
 - D. Body width does not include interlead flash. Interlead flash shall not exceed 0.50 per side.
 - E. Falls within JEDEC MO-187 variation AA, except interlead flash.



- NOTES:
- A. All linear dimensions are in millimeters.
 - B. This drawing is subject to change without notice.
 - C. Publication IPC-7351 is recommended for alternate designs.
 - D. Laser cutting apertures with trapezoidal walls and also rounding corners will offer better paste release. Customers should contact their board assembly site for stencil design recommendations. Refer to IPC-7525 for other stencil recommendations.
 - E. Customers should contact their board fabrication site for solder mask tolerances between and around signal pads.

D (R-PDSO-G8)

PLASTIC SMALL OUTLINE

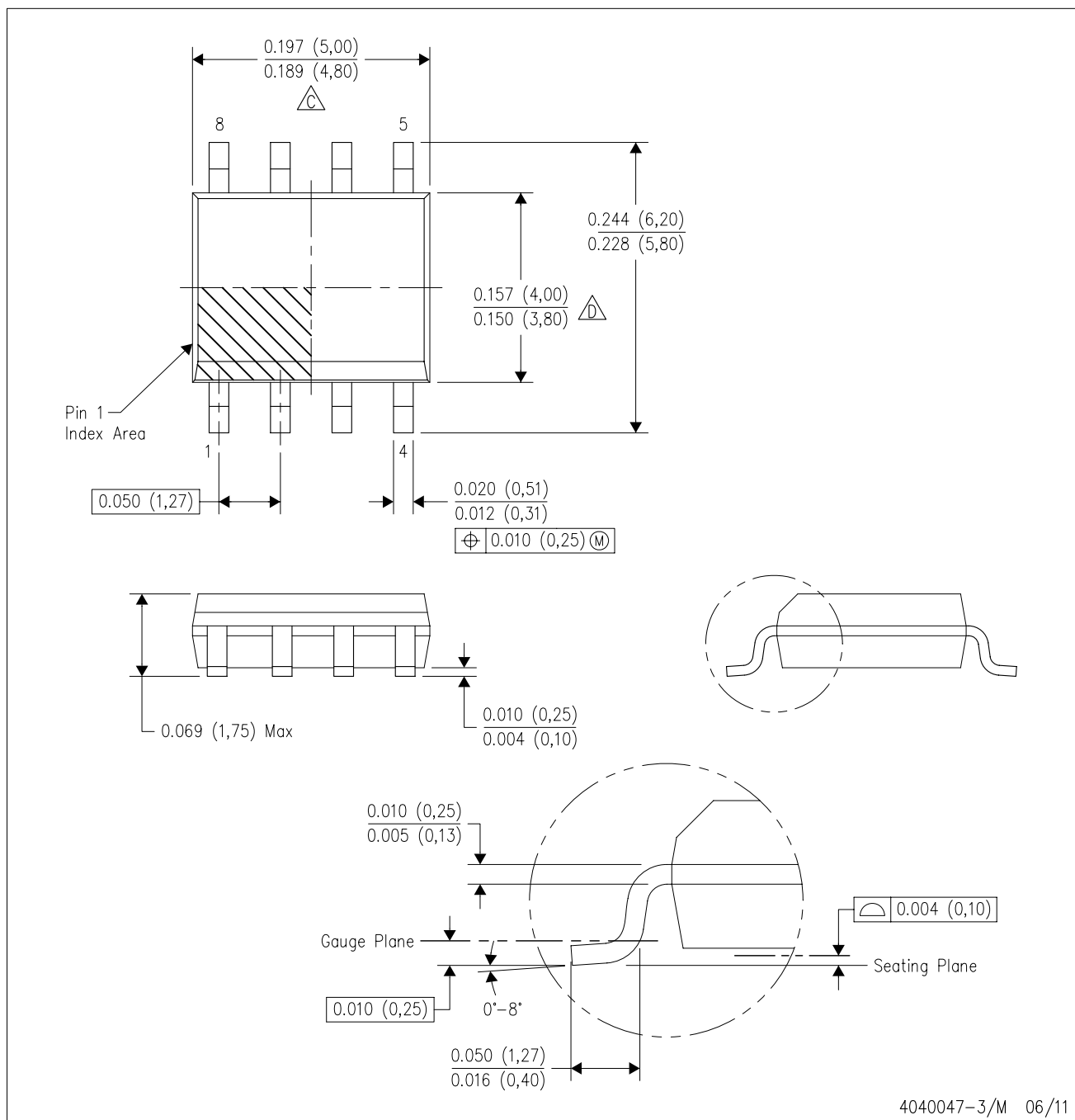

4040047-3/M 06/11

- NOTES:
- A. All linear dimensions are in inches (millimeters).
 - B. This drawing is subject to change without notice.
 - $\triangle C$ Body length does not include mold flash, protrusions, or gate burrs. Mold flash, protrusions, or gate burrs shall not exceed 0.006 (0,15) each side.
 - $\triangle D$ Body width does not include interlead flash. Interlead flash shall not exceed 0.017 (0,43) each side.
 - E. Reference JEDEC MS-012 variation AA.

D (R-PDSO-G8)

PLASTIC SMALL OUTLINE



- NOTES:
- All linear dimensions are in millimeters.
 - This drawing is subject to change without notice.
 - Publication IPC-7351 is recommended for alternate designs.
 - Laser cutting apertures with trapezoidal walls and also rounding corners will offer better paste release. Customers should contact their board assembly site for stencil design recommendations. Refer to IPC-7525 for other stencil recommendations.
 - Customers should contact their board fabrication site for solder mask tolerances between and around signal pads.

IMPORTANT NOTICE

Texas Instruments Incorporated and its subsidiaries (TI) reserve the right to make corrections, enhancements, improvements and other changes to its semiconductor products and services per JESD46, latest issue, and to discontinue any product or service per JESD48, latest issue. Buyers should obtain the latest relevant information before placing orders and should verify that such information is current and complete. All semiconductor products (also referred to herein as "components") are sold subject to TI's terms and conditions of sale supplied at the time of order acknowledgment.

TI warrants performance of its components to the specifications applicable at the time of sale, in accordance with the warranty in TI's terms and conditions of sale of semiconductor products. Testing and other quality control techniques are used to the extent TI deems necessary to support this warranty. Except where mandated by applicable law, testing of all parameters of each component is not necessarily performed.

TI assumes no liability for applications assistance or the design of Buyers' products. Buyers are responsible for their products and applications using TI components. To minimize the risks associated with Buyers' products and applications, Buyers should provide adequate design and operating safeguards.

TI does not warrant or represent that any license, either express or implied, is granted under any patent right, copyright, mask work right, or other intellectual property right relating to any combination, machine, or process in which TI components or services are used. Information published by TI regarding third-party products or services does not constitute a license to use such products or services or a warranty or endorsement thereof. Use of such information may require a license from a third party under the patents or other intellectual property of the third party, or a license from TI under the patents or other intellectual property of TI.

Reproduction of significant portions of TI information in TI data books or data sheets is permissible only if reproduction is without alteration and is accompanied by all associated warranties, conditions, limitations, and notices. TI is not responsible or liable for such altered documentation. Information of third parties may be subject to additional restrictions.

Resale of TI components or services with statements different from or beyond the parameters stated by TI for that component or service voids all express and any implied warranties for the associated TI component or service and is an unfair and deceptive business practice. TI is not responsible or liable for any such statements.

Buyer acknowledges and agrees that it is solely responsible for compliance with all legal, regulatory and safety-related requirements concerning its products, and any use of TI components in its applications, notwithstanding any applications-related information or support that may be provided by TI. Buyer represents and agrees that it has all the necessary expertise to create and implement safeguards which anticipate dangerous consequences of failures, monitor failures and their consequences, lessen the likelihood of failures that might cause harm and take appropriate remedial actions. Buyer will fully indemnify TI and its representatives against any damages arising out of the use of any TI components in safety-critical applications.

In some cases, TI components may be promoted specifically to facilitate safety-related applications. With such components, TI's goal is to help enable customers to design and create their own end-product solutions that meet applicable functional safety standards and requirements. Nonetheless, such components are subject to these terms.

No TI components are authorized for use in FDA Class III (or similar life-critical medical equipment) unless authorized officers of the parties have executed a special agreement specifically governing such use.

Only those TI components which TI has specifically designated as military grade or "enhanced plastic" are designed and intended for use in military/aerospace applications or environments. Buyer acknowledges and agrees that any military or aerospace use of TI components which have **not** been so designated is solely at the Buyer's risk, and that Buyer is solely responsible for compliance with all legal and regulatory requirements in connection with such use.

TI has specifically designated certain components as meeting ISO/TS16949 requirements, mainly for automotive use. In any case of use of non-designated products, TI will not be responsible for any failure to meet ISO/TS16949.

Products

Audio	www.ti.com/audio
Amplifiers	amplifier.ti.com
Data Converters	dataconverter.ti.com
DLP® Products	www.dlp.com
DSP	dsp.ti.com
Clocks and Timers	www.ti.com/clocks
Interface	interface.ti.com
Logic	logic.ti.com
Power Mgmt	power.ti.com
Microcontrollers	microcontroller.ti.com
RFID	www.ti-rfid.com
OMAP Applications Processors	www.ti.com/omap
Wireless Connectivity	www.ti.com/wirelessconnectivity

Applications

Automotive and Transportation	www.ti.com/automotive
Communications and Telecom	www.ti.com/communications
Computers and Peripherals	www.ti.com/computers
Consumer Electronics	www.ti.com/consumer-apps
Energy and Lighting	www.ti.com/energy
Industrial	www.ti.com/industrial
Medical	www.ti.com/medical
Security	www.ti.com/security
Space, Avionics and Defense	www.ti.com/space-avionics-defense
Video and Imaging	www.ti.com/video

TI E2E Community

e2e.ti.com