

LF412 Low Offset, Low Drift Dual JFET Input Operational Amplifier

 Check for Samples: [LF412-N](#)

FEATURES

- Internally Trimmed Offset Voltage: 1 mV (max)
- Input Offset Voltage Drift: 10 $\mu\text{V}/^\circ\text{C}$ (max)
- Low Input Bias Current: 50 pA
- Low Input Noise Current: 0.01 pA / $\sqrt{\text{Hz}}$
- Wide Gain Bandwidth: 3 MHz (min)
- High Slew Rate: 10V/ μs (min)
- Low Supply Current: 1.8 mA/Amplifier
- High Input Impedance: $10^{12}\Omega$
- Low Total Harmonic Distortion: $\leq 0.02\%$
- Low 1/f Noise Corner: 50 Hz
- Fast Settling Time to 0.01%: 2 μs

DESCRIPTION

These devices are low cost, high speed, JFET input operational amplifiers with very low input offset voltage and guaranteed input offset voltage drift. They require low supply current yet maintain a large gain bandwidth product and fast slew rate. In addition, well matched high voltage JFET input devices provide very low input bias and offset currents. The LF412 dual is pin compatible with the LM1558, allowing designers to immediately upgrade the overall performance of existing designs.

These amplifiers may be used in applications such as high speed integrators, fast D/A converters, sample and hold circuits and many other circuits requiring low input offset voltage and drift, low input bias current, high input impedance, high slew rate and wide bandwidth.

Typical Connection

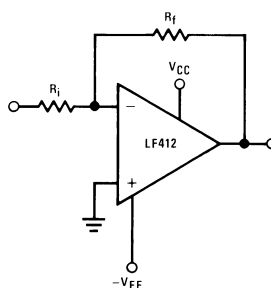
Figure 1.

Connection Diagram

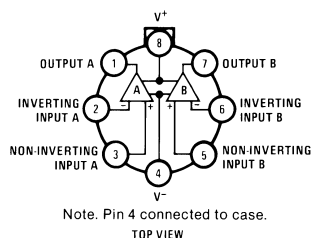
**Figure 2. TO Package – Top View
See Package Number NEV0008A**

Please be aware that an important notice concerning availability, standard warranty, and use in critical applications of Texas Instruments semiconductor products and disclaimers thereto appears at the end of this data sheet.

BI-FET II is a trademark of Texas Instruments.

All other trademarks are the property of their respective owners.

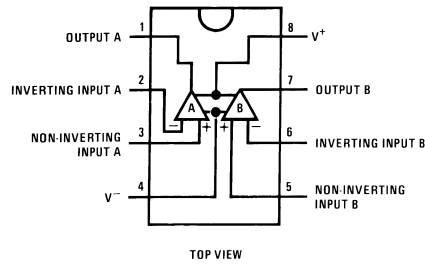
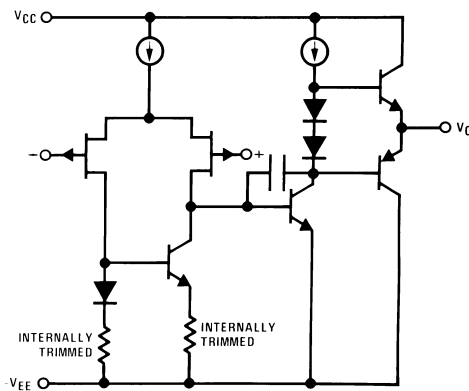

Figure 3. PDIP/CDIP Package – Top View
See Package Number P0008E or NAB0008A

Simplified Schematic



(1) Available per JM38510/11905

Figure 4. 1/2 Dual

Detailed Schematic

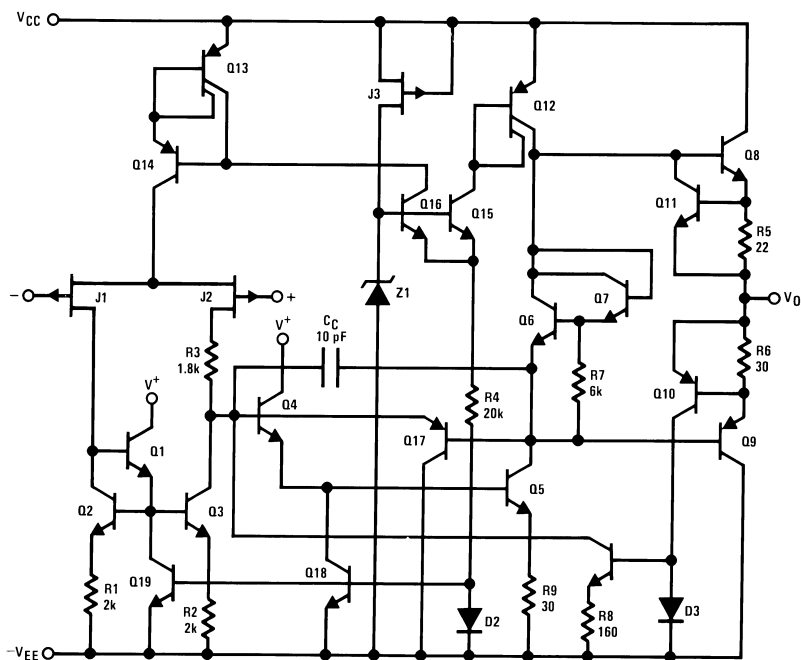

Figure 5.



These devices have limited built-in ESD protection. The leads should be shorted together or the device placed in conductive foam during storage or handling to prevent electrostatic damage to the MOS gates.

Absolute Maximum Ratings ⁽¹⁾ ⁽²⁾

	LF412A	LF412
Supply Voltage	±22V	±18V
Differential Input Voltage	±38V	±30V
Input voltage Range ⁽³⁾		
Output Short Circuit Duration ⁽⁴⁾	Continuous	Continuous
	TO Package	PDIP Package
Power Dissipation ⁽⁵⁾	See ⁽⁶⁾	670 mW
T _j max	150°C	115°C
θ _{JA} (Typical)	152°C/W	115°C/W
Operating Temp. Range	See ⁽⁷⁾	See ⁽⁷⁾
Storage Temp. Range	-65°C ≤ T _A ≤ 150°C	-65°C ≤ T _A ≤ 150°C
Lead Temp. (Soldering, 10 sec.)	260°C	260°C
ESD Tolerance ⁽⁸⁾	1700V	1700V

- (1) “Absolute Maximum Ratings” indicate limits beyond which damage to the device may occur. Operating Ratings indicate conditions for which the device is functional, but do not guarantee specific performance limits.
- (2) Refer to RETS412X for LF412MH and LF412MJ military specifications.
- (3) Unless otherwise specified the absolute maximum negative input voltage is equal to the negative power supply voltage.
- (4) Any of the amplifier outputs can be shorted to ground indefinitely, however, more than one should not be simultaneously shorted as the maximum junction temperature will be exceeded.
- (5) Max. Power Dissipation is defined by the package characteristics. Operating the part near the Max. Power Dissipation may cause the part to operate outside guaranteed limits.
- (6) For operating at elevated temperature, these devices must be derated based on a thermal resistance of θ_{JA}.
- (7) These devices are available in both the commercial temperature range 0°C ≤ T_A ≤ 70°C and the military temperature range -55°C ≤ T_A ≤ 125°C. The temperature range is designated by the position just before the package type in the device number. A “C” indicates the commercial temperature range and an “M” indicates the military temperature range. The military temperature range is available in TO package only. In all cases the maximum operating temperature is limited by internal junction temperature T_j max.
- (8) Human body model, 1.5 kΩ in series with 100 pF.

DC Electrical Characteristics

Symbol	Parameter	Conditions	LF412A ⁽¹⁾			LF412 ⁽¹⁾			Units
			Min	Typ	Max	Min	Typ	Max	
V_{OS}	Input Offset Voltage	$R_S=10\text{ k}\Omega$, $T_A=25^\circ\text{C}$		0.5	1.0		1.0	3.0	mV
$\Delta V_{OS}/\Delta T$	Average TC of Input Offset Voltage	$R_S=10\text{ k}\Omega$ ⁽²⁾		7	10		7	20	$\mu\text{V}/^\circ\text{C}$
I_{OS}	Input Offset Current	$V_S=\pm 15\text{V}$ ^{(1) (3)}	$T_J=25^\circ\text{C}$	25	100		25	100	pA
			$T_J=70^\circ\text{C}$			2		2	nA
			$T_J=125^\circ\text{C}$			25		25	nA
I_B	Input Bias Current	$V_S=\pm 15\text{V}$ ^{(1) (3)}	$T_J=25^\circ\text{C}$	50	200		50	200	pA
			$T_J=70^\circ\text{C}$			4		4	nA
			$T_J=125^\circ\text{C}$			50		50	nA
R_{IN}	Input Resistance	$T_J=25^\circ\text{C}$		10^{12}		10^{12}		Ω	
A_{VOL}	Large Signal Voltage Gain	$R_L=2\text{ k}\Omega$, $T_A=25^\circ\text{C}$	50	200		25	200		V/mV
		$V_S=\pm 15\text{V}$, $V_O=\pm 10\text{V}$, Over Temperature	25	200		15	200		V/mV
V_O	Output Voltage Swing	$V_S=\pm 15\text{V}$, $R_L=10\text{ k}\Omega$	± 12	± 13.5		± 12	± 13.5		V
V_{CM}	Input Common-Mode Voltage Range		± 16	+19.5		± 11	+14.5		V
				-16.5			-11.5		V
CMRR	Common-Mode Rejection Ratio	$R_S\leq 10\text{ k}\Omega$	80	100		70	100		dB
PSRR	Supply Voltage Rejection Ratio		⁽⁴⁾ 80	100		70	100		dB
I_S	Supply Current	$V_O = 0\text{V}$, $R_L = \infty$		3.6	5.6		3.6	6.5	mA

- (1) Unless otherwise specified, the specifications apply over the full temperature range and for $V_S=\pm 20\text{V}$ for the LF412A and for $V_S=\pm 15\text{V}$ for the LF412. V_{OS} , I_B , and I_{OS} are measured at $V_{CM}=0$.
- (2) The LF412A is 100% tested to this specification. The LF412 is sample tested on a per amplifier basis to insure at least 85% of the amplifiers meet this specification.
- (3) The input bias currents are junction leakage currents which approximately double for every 10°C increase in the junction temperature, T_J . Due to limited production test time, the input bias currents measured are correlated to junction temperature. In normal operation the junction temperature rises above the ambient temperature as a result of internal power dissipation, P_D . $T_J=T_A+\theta_{JA} P_D$ where θ_{JA} is the thermal resistance from junction to ambient. Use of a heat sink is recommended if input bias current is to be kept to a minimum.
- (4) Supply voltage rejection ratio is measured for both supply magnitudes increasing or decreasing simultaneously in accordance with common practice. $V_S = \pm 6\text{V}$ to $\pm 15\text{V}$.

AC Electrical Characteristics

Symbol	Parameter	Conditions	LF412A ⁽¹⁾			LF412 ⁽¹⁾			Units
			Min	Typ	Max	Min	Typ	Max	
	Amplifier to Amplifier Coupling	$T_A=25^\circ\text{C}$, $f=1\text{ Hz}-20\text{ kHz}$ (Input Referred)		-120			-120		dB
SR	Slew Rate	$V_S=\pm 15\text{V}$, $T_A=25^\circ\text{C}$	10	15		8	15		V/ μs
GBW	Gain-Bandwidth Product	$V_S=\pm 15\text{V}$, $T_A=25^\circ\text{C}$	3	4		2.7	4		MHz
THD	Total Harmonic Dist	$A_V=+10$, $R_L=10\text{ k}\Omega$, $V_O=20\text{ Vp-p}$, $BW=20\text{ Hz}-20\text{ kHz}$		≤ 0.02			≤ 0.02		%
e_n	Equivalent Input Noise Voltage	$T_A=25^\circ\text{C}$, $R_S=100\Omega$, $f=1\text{ kHz}$		25			25		nV / $\sqrt{\text{Hz}}$
i_n	Equivalent Input Noise Current	$T_A=25^\circ\text{C}$, $f=1\text{ kHz}$		0.01			0.01		pA / $\sqrt{\text{Hz}}$

- (1) Unless otherwise specified, the specifications apply over the full temperature range and for $V_S=\pm 20\text{V}$ for the LF412A and for $V_S=\pm 15\text{V}$ for the LF412. V_{OS} , I_B , and I_{OS} are measured at $V_{CM}=0$.

Typical Performance Characteristics

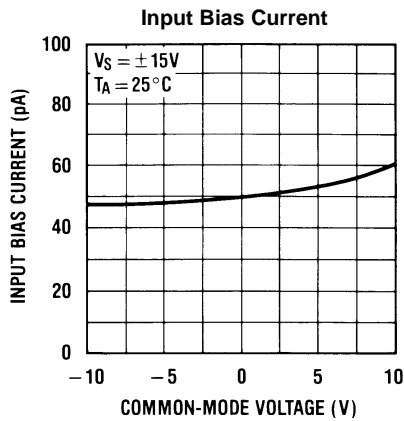

Figure 6.

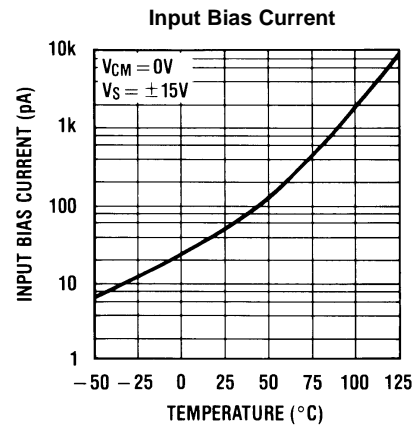

Figure 7.

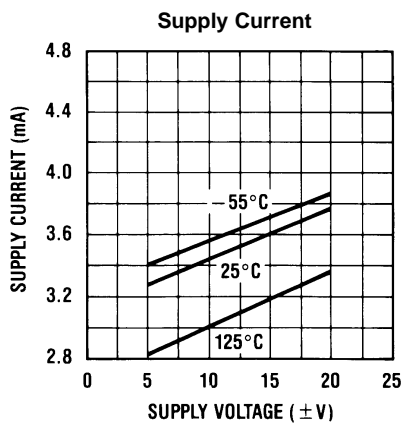

Figure 8.

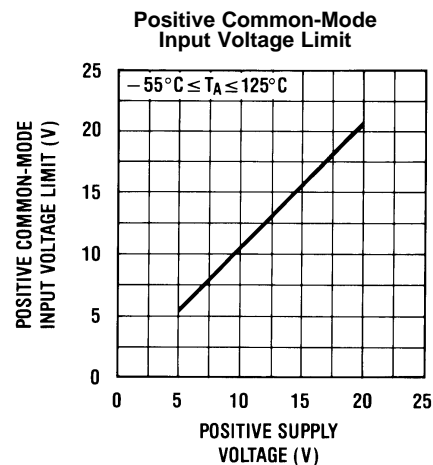

Figure 9.

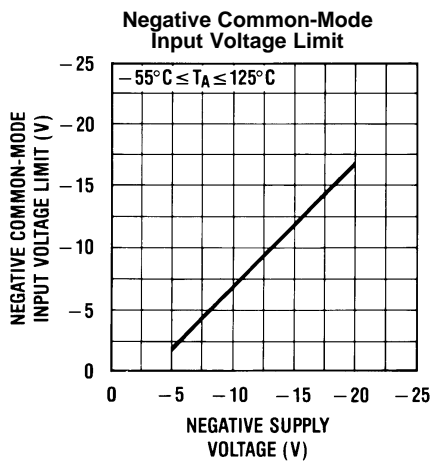

Figure 10.

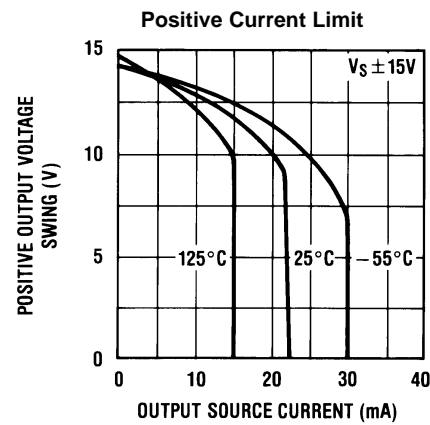

Figure 11.

Typical Performance Characteristics (continued)

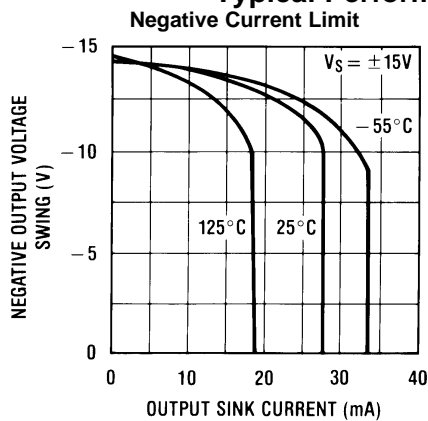

Figure 12.

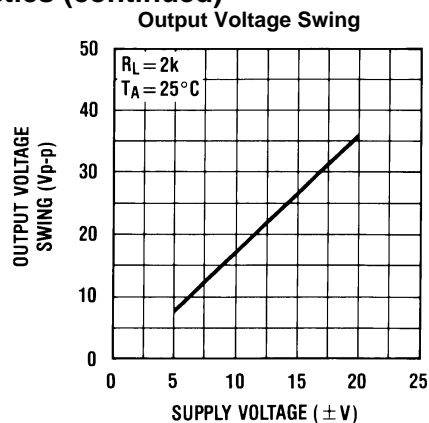

Figure 13.

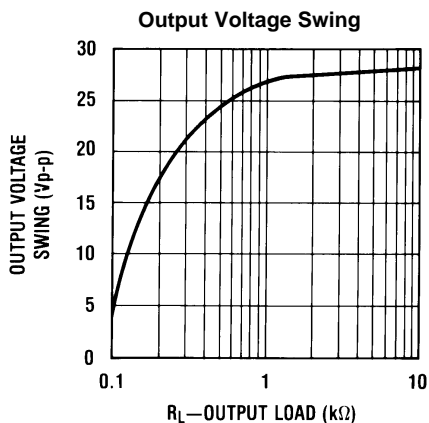

Figure 14.

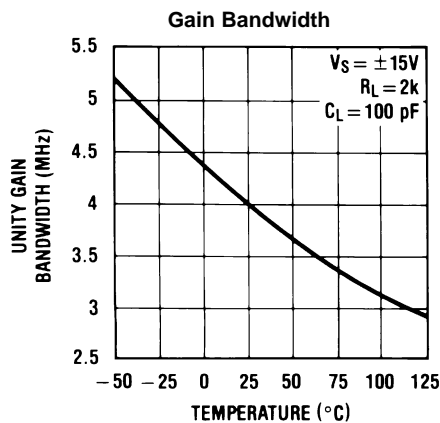

Figure 15.

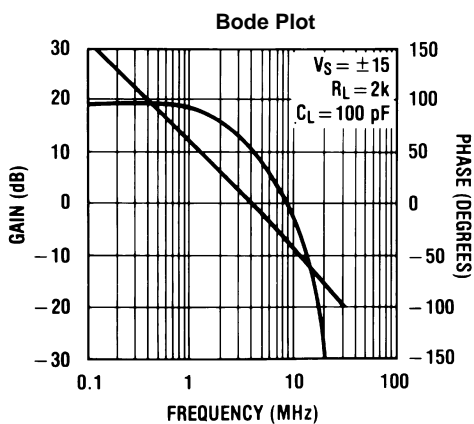

Figure 16.

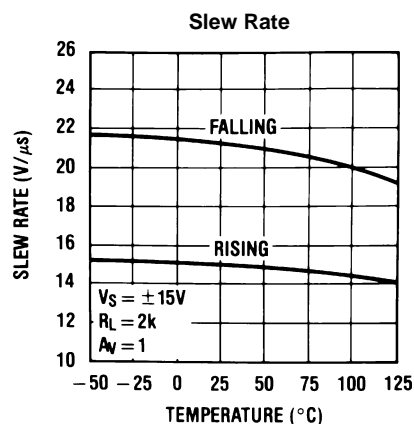
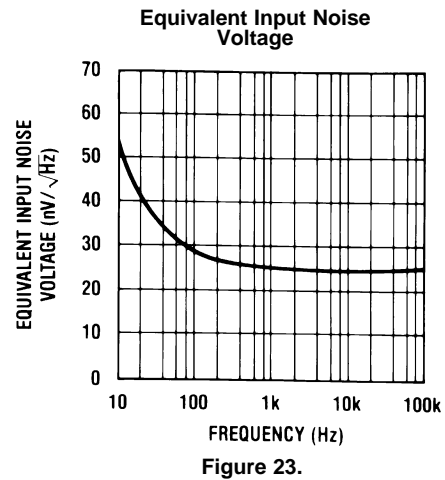
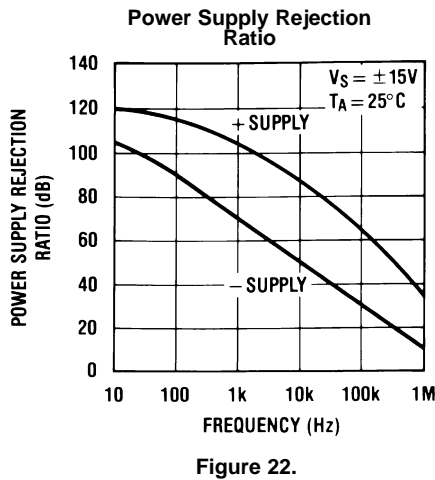
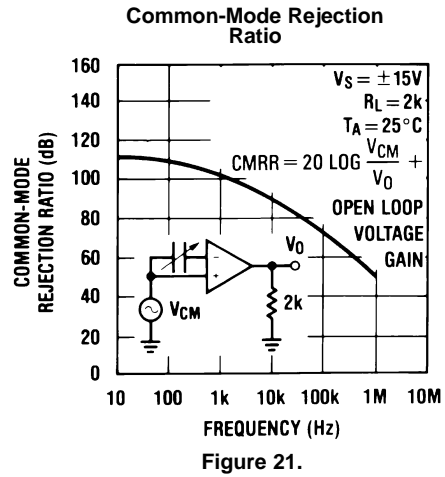
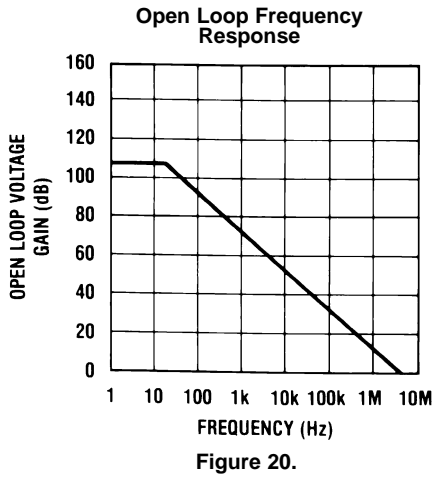
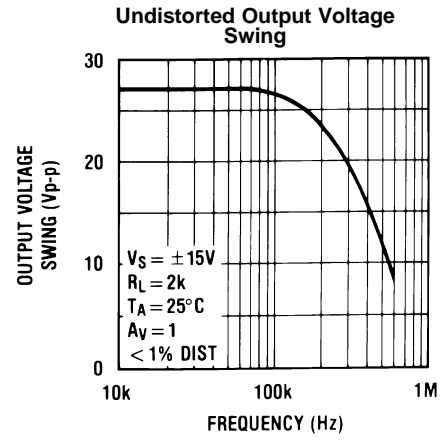
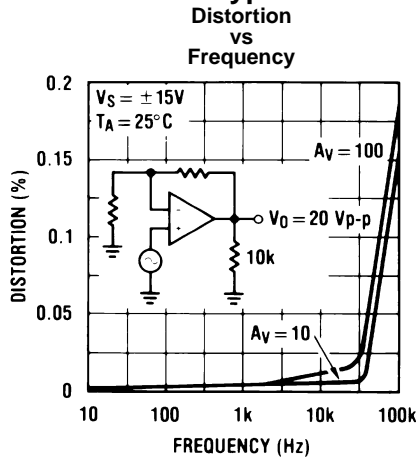

Figure 17.

Typical Performance Characteristics (continued)



Typical Performance Characteristics (continued)

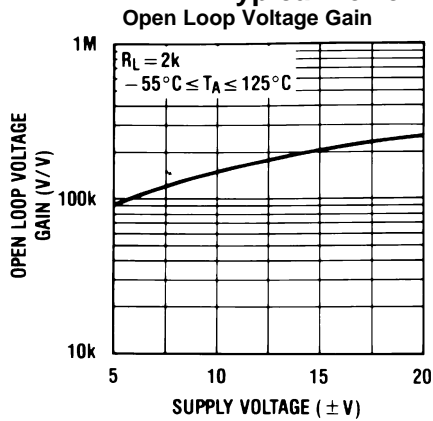

Figure 24.

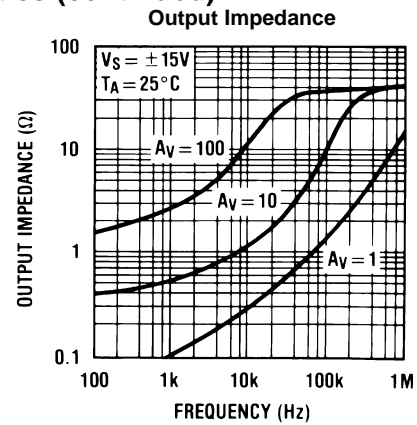

Figure 25.

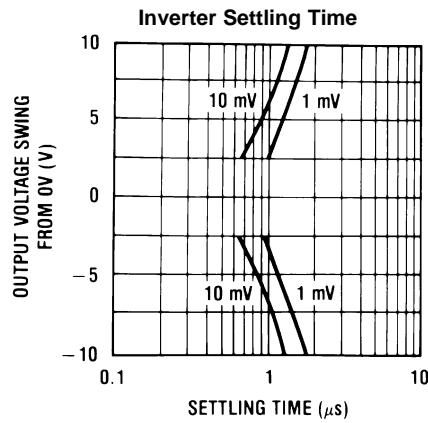

Figure 26.

PULSE RESPONSE

$R_L=2\text{ k}\Omega$, $C_L=10\text{ pF}$

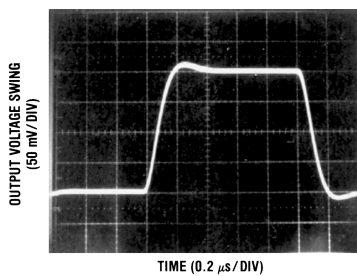

Figure 27. Small Signal Inverting

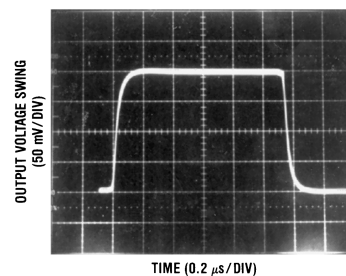

Figure 28. Small Signal Non-Inverting

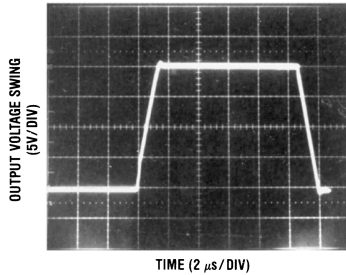

Figure 29. Large Signal Inverting

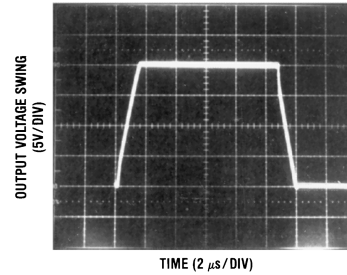

Figure 30. Large Signal Non-Inverting

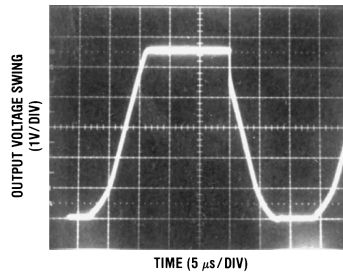

Figure 31. Current Limit ($R_L=100\Omega$)

APPLICATION HINTS

The LF412 series of JFET input dual op amps are internally trimmed (BI-FET II™) providing very low input offset voltages and guaranteed input offset voltage drift. These JFETs have large reverse breakdown voltages from gate to source and drain eliminating the need for clamps across the inputs. Therefore, large differential input voltages can easily be accommodated without a large increase in input current. The maximum differential input voltage is independent of the supply voltages. However, neither of the input voltages should be allowed to exceed the negative supply as this will cause large currents to flow which can result in a destroyed unit.

Exceeding the negative common-mode limit on either input will cause a reversal of the phase to the output and force the amplifier output to the corresponding high or low state.

Exceeding the negative common-mode limit on both inputs will force the amplifier output to a high state. In neither case does a latch occur since raising the input back within the common-mode range again puts the input stage and thus the amplifier in a normal operating mode.

Exceeding the positive common-mode limit on a single input will not change the phase of the output, however, if both inputs exceed the limit, the output of the amplifier may be forced to a high state.

The amplifiers will operate with a common-mode input voltage equal to the positive supply; however, the gain bandwidth and slew rate may be decreased in this condition. When the negative common-mode voltage swings to within 3V of the negative supply, an increase in input offset voltage may occur.

Each amplifier is individually biased by a zener reference which allows normal circuit operation on $\pm 6.0V$ power supplies. Supply voltages less than these may result in lower gain bandwidth and slew rate.

The amplifiers will drive a 2 k Ω load resistance to $\pm 10V$ over the full temperature range. If the amplifier is forced to drive heavier load currents, however, an increase in input offset voltage may occur on the negative voltage swing and finally reach an active current limit on both positive and negative swings.

Precautions should be taken to ensure that the power supply for the integrated circuit never becomes reversed in polarity or that the unit is not inadvertently installed backwards in a socket as an unlimited current surge through the resulting forward diode within the IC could cause fusing of the internal conductors and result in a destroyed unit.

As with most amplifiers, care should be taken with lead dress, component placement and supply decoupling in order to ensure stability. For example, resistors from the output to an input should be placed with the body close to the input to minimize “pick-up” and maximize the frequency of the feedback pole by minimizing the capacitance from the input to ground.

A feedback pole is created when the feedback around any amplifier is resistive. The parallel resistance and capacitance from the input of the device (usually the inverting input) to AC ground set the frequency of the pole. In many instances the frequency of this pole is much greater than the expected 3 dB frequency of the closed loop gain and consequently there is negligible effect on stability margin. However, if the feedback pole is less than approximately 6 times the expected 3 dB frequency a lead capacitor should be placed from the output to the input of the op amp. The value of the added capacitor should be such that the RC time constant of this capacitor and the resistance it parallels is greater than or equal to the original feedback pole time constant.

TYPICAL APPLICATION

Figure 32. Single Supply Sample and Hold

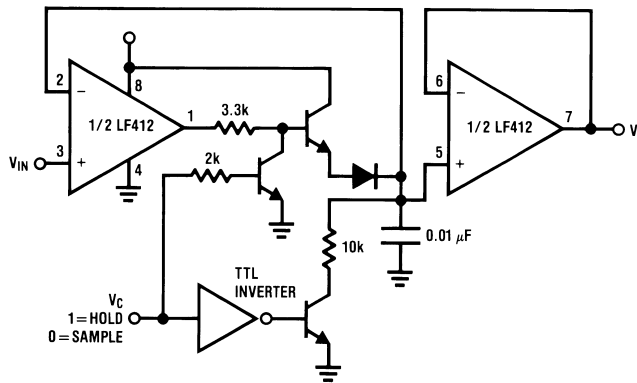

REVISION HISTORY

Changes from Revision D (March 2013) to Revision E	Page
• Changed layout of National Data Sheet to TI format	11

PACKAGING INFORMATION

Orderable Device	Status (1)	Package Type	Package Drawing	Pins	Package Qty	Eco Plan (2)	Lead/Ball Finish (6)	MSL Peak Temp (3)	Op Temp (°C)	Device Marking (4/5)	Samples
LF412ACN	NRND	PDIP	P	8	40	TBD	Call TI	Call TI	0 to 70	LF 412ACN	
LF412ACN/NOPB	ACTIVE	PDIP	P	8	40	Green (RoHS & no Sb/Br)	CU SN	Level-1-NA-UNLIM	0 to 70	LF 412ACN	Samples
LF412CN	NRND	PDIP	P	8	40	TBD	Call TI	Call TI	0 to 70	LF 412CN	
LF412CN/NOPB	ACTIVE	PDIP	P	8	40	Green (RoHS & no Sb/Br)	CU SN	Level-1-NA-UNLIM	0 to 70	LF 412CN	Samples
LF412MH	ACTIVE	TO	NEV	8	500	TBD	Call TI	Call TI	-55 to 125	LF412MH	Samples
LF412MH/NOPB	ACTIVE	TO	NEV	8	500	Green (RoHS & no Sb/Br)	POST-PLATE	Level-1-NA-UNLIM	-55 to 125	LF412MH	Samples

(1) The marketing status values are defined as follows:

ACTIVE: Product device recommended for new designs.

LIFEBUY: TI has announced that the device will be discontinued, and a lifetime-buy period is in effect.

NRND: Not recommended for new designs. Device is in production to support existing customers, but TI does not recommend using this part in a new design.

PREVIEW: Device has been announced but is not in production. Samples may or may not be available.

OBSOLETE: TI has discontinued the production of the device.

(2) Eco Plan - The planned eco-friendly classification: Pb-Free (RoHS), Pb-Free (RoHS Exempt), or Green (RoHS & no Sb/Br) - please check <http://www.ti.com/productcontent> for the latest availability information and additional product content details.

TBD: The Pb-Free/Green conversion plan has not been defined.

Pb-Free (RoHS): TI's terms "Lead-Free" or "Pb-Free" mean semiconductor products that are compatible with the current RoHS requirements for all 6 substances, including the requirement that lead not exceed 0.1% by weight in homogeneous materials. Where designed to be soldered at high temperatures, TI Pb-Free products are suitable for use in specified lead-free processes.

Pb-Free (RoHS Exempt): This component has a RoHS exemption for either 1) lead-based flip-chip solder bumps used between the die and package, or 2) lead-based die adhesive used between the die and leadframe. The component is otherwise considered Pb-Free (RoHS compatible) as defined above.

Green (RoHS & no Sb/Br): TI defines "Green" to mean Pb-Free (RoHS compatible), and free of Bromine (Br) and Antimony (Sb) based flame retardants (Br or Sb do not exceed 0.1% by weight in homogeneous material)

(3) MSL, Peak Temp. - The Moisture Sensitivity Level rating according to the JEDEC industry standard classifications, and peak solder temperature.

(4) There may be additional marking, which relates to the logo, the lot trace code information, or the environmental category on the device.

(5) Multiple Device Markings will be inside parentheses. Only one Device Marking contained in parentheses and separated by a "-" will appear on a device. If a line is indented then it is a continuation of the previous line and the two combined represent the entire Device Marking for that device.

⁽⁶⁾ Lead/Ball Finish - Orderable Devices may have multiple material finish options. Finish options are separated by a vertical ruled line. Lead/Ball Finish values may wrap to two lines if the finish value exceeds the maximum column width.

Important Information and Disclaimer: The information provided on this page represents TI's knowledge and belief as of the date that it is provided. TI bases its knowledge and belief on information provided by third parties, and makes no representation or warranty as to the accuracy of such information. Efforts are underway to better integrate information from third parties. TI has taken and continues to take reasonable steps to provide representative and accurate information but may not have conducted destructive testing or chemical analysis on incoming materials and chemicals. TI and TI suppliers consider certain information to be proprietary, and thus CAS numbers and other limited information may not be available for release.

In no event shall TI's liability arising out of such information exceed the total purchase price of the TI part(s) at issue in this document sold by TI to Customer on an annual basis.

P (R-PDIP-T8)

PLASTIC DUAL-IN-LINE PACKAGE



- NOTES:
- A. All linear dimensions are in inches (millimeters).
 - B. This drawing is subject to change without notice.
 - C. Falls within JEDEC MS-001 variation BA.

NEV0008A

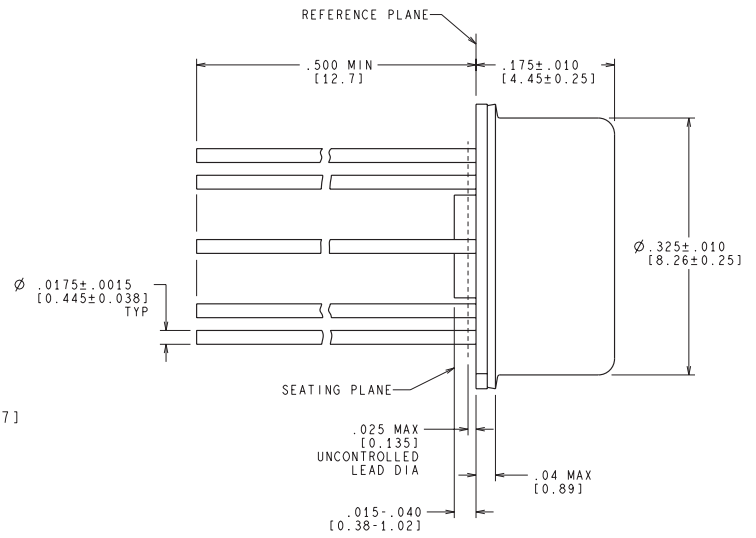
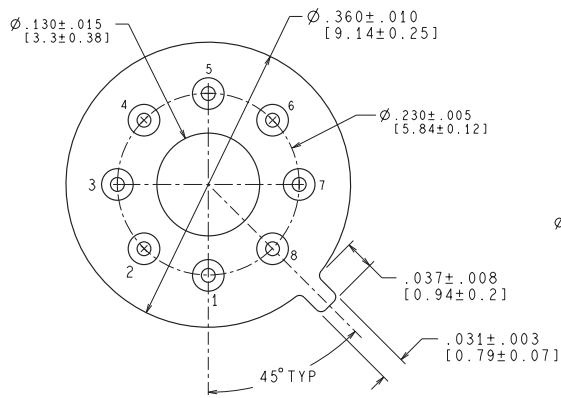

MIL-PRF-38535
CONFIGURATION CONTROL

CONTROLLING DIMENSION IS INCH
VALUES IN [] ARE IN MILLIMETERS

H08A (REV C)

IMPORTANT NOTICE

Texas Instruments Incorporated and its subsidiaries (TI) reserve the right to make corrections, enhancements, improvements and other changes to its semiconductor products and services per JESD46, latest issue, and to discontinue any product or service per JESD48, latest issue. Buyers should obtain the latest relevant information before placing orders and should verify that such information is current and complete. All semiconductor products (also referred to herein as "components") are sold subject to TI's terms and conditions of sale supplied at the time of order acknowledgment.

TI warrants performance of its components to the specifications applicable at the time of sale, in accordance with the warranty in TI's terms and conditions of sale of semiconductor products. Testing and other quality control techniques are used to the extent TI deems necessary to support this warranty. Except where mandated by applicable law, testing of all parameters of each component is not necessarily performed.

TI assumes no liability for applications assistance or the design of Buyers' products. Buyers are responsible for their products and applications using TI components. To minimize the risks associated with Buyers' products and applications, Buyers should provide adequate design and operating safeguards.

TI does not warrant or represent that any license, either express or implied, is granted under any patent right, copyright, mask work right, or other intellectual property right relating to any combination, machine, or process in which TI components or services are used. Information published by TI regarding third-party products or services does not constitute a license to use such products or services or a warranty or endorsement thereof. Use of such information may require a license from a third party under the patents or other intellectual property of the third party, or a license from TI under the patents or other intellectual property of TI.

Reproduction of significant portions of TI information in TI data books or data sheets is permissible only if reproduction is without alteration and is accompanied by all associated warranties, conditions, limitations, and notices. TI is not responsible or liable for such altered documentation. Information of third parties may be subject to additional restrictions.

Resale of TI components or services with statements different from or beyond the parameters stated by TI for that component or service voids all express and any implied warranties for the associated TI component or service and is an unfair and deceptive business practice. TI is not responsible or liable for any such statements.

Buyer acknowledges and agrees that it is solely responsible for compliance with all legal, regulatory and safety-related requirements concerning its products, and any use of TI components in its applications, notwithstanding any applications-related information or support that may be provided by TI. Buyer represents and agrees that it has all the necessary expertise to create and implement safeguards which anticipate dangerous consequences of failures, monitor failures and their consequences, lessen the likelihood of failures that might cause harm and take appropriate remedial actions. Buyer will fully indemnify TI and its representatives against any damages arising out of the use of any TI components in safety-critical applications.

In some cases, TI components may be promoted specifically to facilitate safety-related applications. With such components, TI's goal is to help enable customers to design and create their own end-product solutions that meet applicable functional safety standards and requirements. Nonetheless, such components are subject to these terms.

No TI components are authorized for use in FDA Class III (or similar life-critical medical equipment) unless authorized officers of the parties have executed a special agreement specifically governing such use.

Only those TI components which TI has specifically designated as military grade or "enhanced plastic" are designed and intended for use in military/aerospace applications or environments. Buyer acknowledges and agrees that any military or aerospace use of TI components which have **not** been so designated is solely at the Buyer's risk, and that Buyer is solely responsible for compliance with all legal and regulatory requirements in connection with such use.

TI has specifically designated certain components as meeting ISO/TS16949 requirements, mainly for automotive use. In any case of use of non-designated products, TI will not be responsible for any failure to meet ISO/TS16949.

Products

Audio	www.ti.com/audio
Amplifiers	amplifier.ti.com
Data Converters	dataconverter.ti.com
DLP® Products	www.dlp.com
DSP	dsp.ti.com
Clocks and Timers	www.ti.com/clocks
Interface	interface.ti.com
Logic	logic.ti.com
Power Mgmt	power.ti.com
Microcontrollers	microcontroller.ti.com
RFID	www.ti-rfid.com
OMAP Applications Processors	www.ti.com/omap
Wireless Connectivity	www.ti.com/wirelessconnectivity

Applications

Automotive and Transportation	www.ti.com/automotive
Communications and Telecom	www.ti.com/communications
Computers and Peripherals	www.ti.com/computers
Consumer Electronics	www.ti.com/consumer-apps
Energy and Lighting	www.ti.com/energy
Industrial	www.ti.com/industrial
Medical	www.ti.com/medical
Security	www.ti.com/security
Space, Avionics and Defense	www.ti.com/space-avionics-defense
Video and Imaging	www.ti.com/video

TI E2E Community

e2e.ti.com